



PRODUCT CATALOGUE



VOLUME 27



FROM SITE CUT TO SAW CUT,
FLEXTOOL OFFERS A COMPLETE
RANGE OF QUALITY PROFESSIONAL
CONCRETE AND CONSTRUCTION
EQUIPMENT.

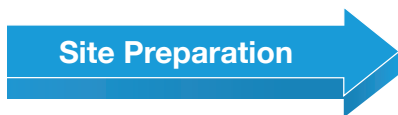







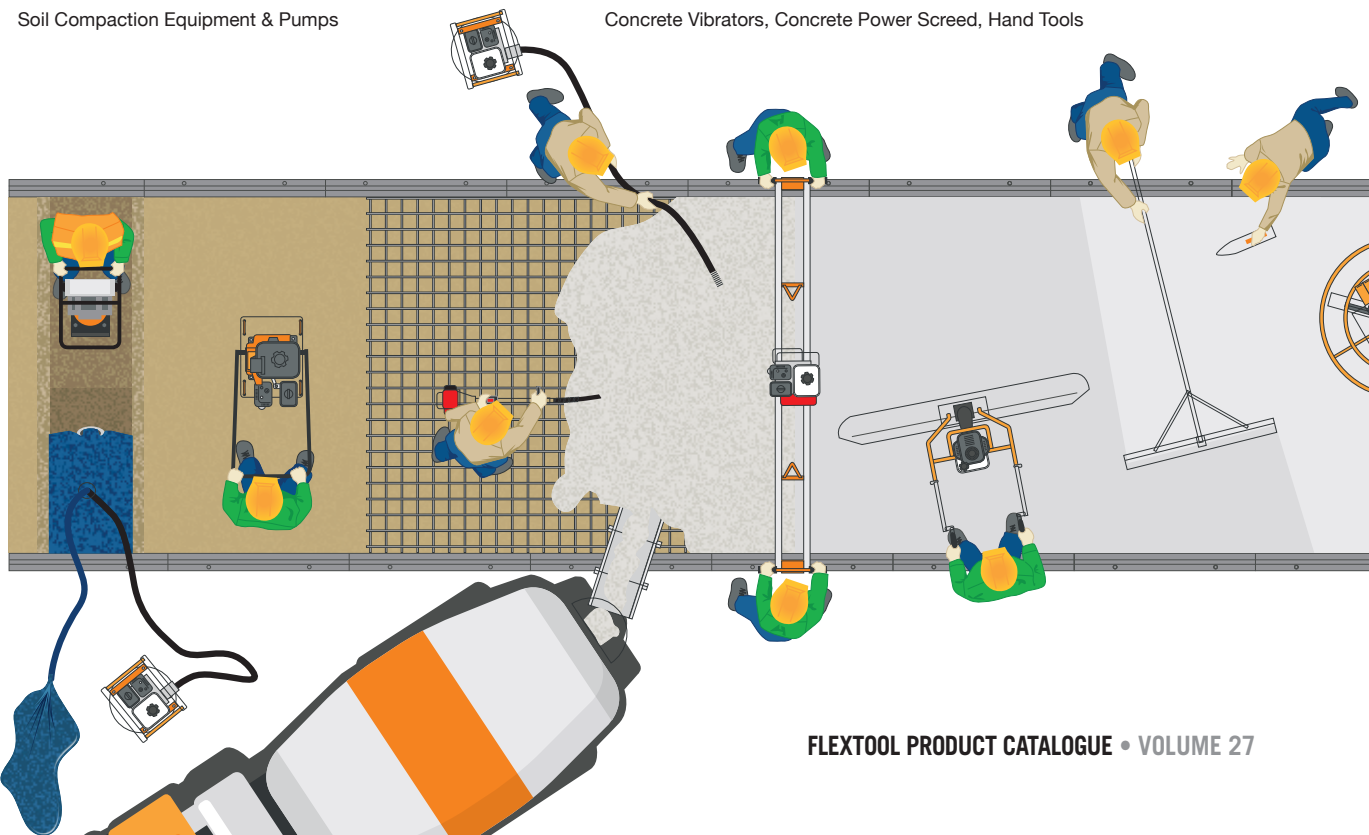



Soil Compaction Equipment & Pumps



Concrete Vibrators, Concrete Power Screed, Hand Tools



	<u>DRIVE UNITS</u> Petrol & Diesel Models	6
	<u>PUMPS</u> Flexshaft Pumps, Lay Flat Hose & Extension Flexshafts	8
	<u>CONCRETE VIBRATORS</u> Flexshaft Concrete Vibrators & PortaVibe	12
	<u>CONCRETE POWER FINISHING</u> Walk-Behind & Ride-On Power Trowels, Trowel Blades & Pan Floats	22
	<u>CONCRETE POWER SCREEDING</u> Portascreed, Double Beam Vibratory Screeds & Truss Screeds	32
	<u>HAND TOOLS</u>	37
	<u>SOIL COMPACTION</u> Tamping Rammers, Forward Plate Compactors & Reversible Plate Compactors	50
	<u>DIAMOND CUTTING & DRILLING</u> Brick Saws, Diamond Blades & Diamond Core Bits	60
	<u>SURFACE PREPARATION</u> Concrete Grinders & Diamond Grinding Consumables & Surface Scarifiers	66
	<u>POWER EQUIPMENT</u> Pressure Cleaner	76
	<u>SPRAYERS</u> Industrial Sprayer	78

Concrete Finishing

Walk-Behind & Ride-On Power Trowels

Concrete Cutting

Brick / Masonry Saw, Diamond Blades

Surface Preparation

Concrete Grinders, Scarifiers & Sprayers

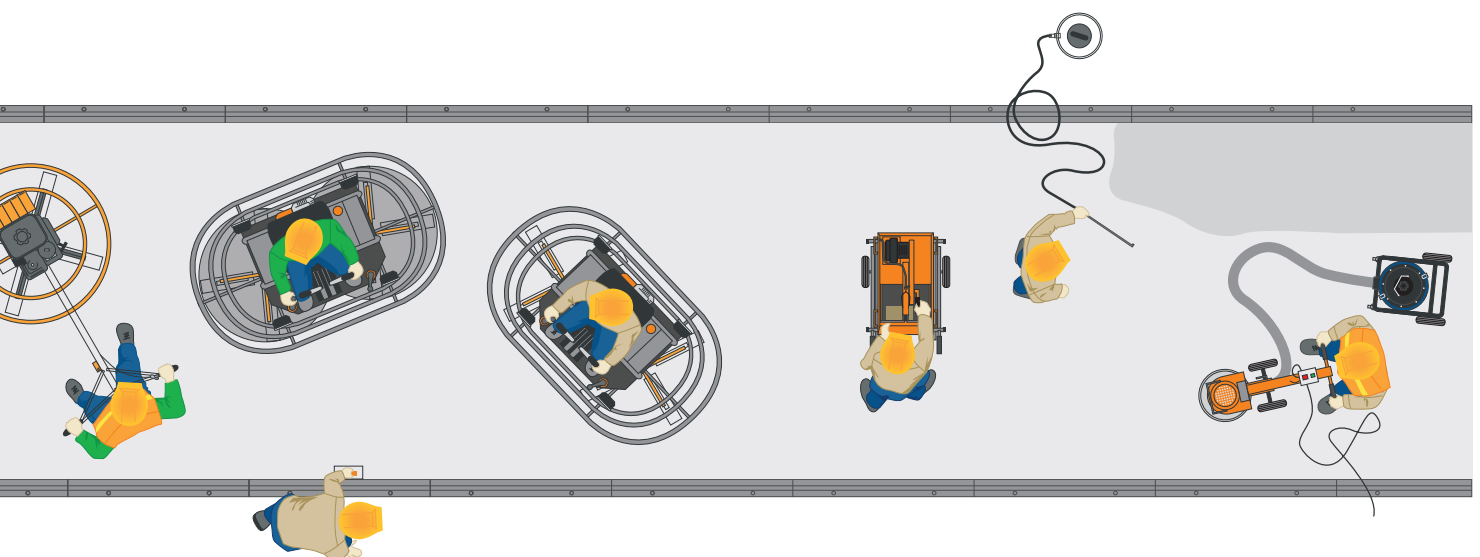



**AT FLEXTOOL
WE KNOW THAT
TIME IS MONEY.**

**THAT'S WHY WE'VE INTRODUCED
THE FLEXTOOL PROMISE.**

**FOR NEARLY 70 YEARS FLEXTOOL
HAVE BEEN SUPPLYING AUSTRALIAN
TRADIES LIKE YOU WITH QUALITY
EQUIPMENT AND TOOLS. WE ARE
COMMITTED TO PROVIDING YOU
WITH THE BEST CONSTRUCTION
EQUIPMENT TO GET YOUR JOB DONE.**



We know that downtime on jobs costs money, so to help limit any downtime due to machinery breakdown we've introduced The Flextool Promise.

To put it simply, if the unexpected happens and something goes wrong with your Flextool equipment within the first 12 months of purchase, we'll help arrange and cover the cost of a loan machine for 2 days, free of charge, while we work to repair or replace your Flextool product.

You just contact us and we'll make it happen.

With Flextool, you can start and finish your work with confidence. That's why we've been trade trusted since 1951.

The Flextool Promise. Job done.



*Terms and conditions apply www.flextool.com.au/flextool-promise/terms-and-conditions/

Flextool® Drive Units

Flextool Drive Units are fitted with a quick action coupling for quick and easy connection of a wide range of flexible shaft submersible pumps and concrete vibrators. They are available with petrol or diesel engines to suit any specific job site requirement.

FLEXTOOL DRIVE UNITS ARE COMPATIBLE WITH ALL FLEXSHAFT PUMPS AND CONCRETE VIBRATORS FITTED WITH A 3-TOOTH DRIVE COUPLING.



Lifting hook for easy and safe onsite handling.

Durable heavy duty motor protection frame.

Honda 4-stroke engine for hassle free operation and low engine emissions (petrol models only).

Heavy duty rubber mounts for vibration isolation (excludes Standard FDU-P1 model).

Dished steel base for easy mobility over concrete reinforcing mesh (Standard FDU-P1 and Super FDU-P2 models only).



Super Drive Unit FDU-P2

POWERED by HONDA

PETROL DRIVE UNITS

Petrol drive units are available with Honda four-stroke motors. An oil level sensor is fitted to protect the motor from a lack of crankcase oil.

APPLICATIONS

- Compatible with Flextool Submersible Pumps and Flextool Flexshaft Concrete Vibrators
- Construction, hire industry & manufacturing industry

POWERED BY
HONDA









FDU-P1 (Standard)



FDU-P2 (Super)



FDU-P3 (Heavy Duty)

Model	Operating Weight (kg)	Engine Speed (rpm)	Vibration Isolating Mounts	Lifting Hook	Engine Make	Engine Model	Max Rated Power (Hp)	Fuel Type	Product Code	Barcode
FDU-P1 (Standard)	28.5	3000	No	Yes	Honda	GX160	5.5		FT201802-UNIT	 9300611599469
FDU-P2 (Super)	32	3000	Yes	Yes	Honda	GX160	5.5		FT201798-UNIT	 9300611599421
FDU-P3 (Heavy Duty)	38.5	3000	Yes	Yes	Honda	GX270	9		FT201799-UNIT	 9300611599438

DIESEL DRIVE UNITS

Diesel drive units are ideal for unattended operation and long term reliability. Available in both recoil or key start for easy operation.

APPLICATIONS

- Compatible with Flextool Submersible Pumps and Flextool Flexshaft Concrete Vibrators
- Hazardous areas including mining, tunnels & refineries





 **YANMAR**



FDU-D2 (Diesel)



FDU-DE2 (Diesel Electric Start)

Model	Operating Weight (kg)	Engine Speed (rpm)	Vibration Isolating Mounts	Lifting Hook	Engine Make	Engine Model	Max Rated Power (Hp)	Fuel Type	Product Code	Barcode
FDU-D2 (Diesel)	38	3000	Yes	Yes	Yanmar	L48	4.8		FT201800-UNIT	 9300611599445
FDU-DE2 (Diesel Electric Start)	52	3000	Yes	Yes	Yanmar - Elec	L48	4.8		FT201819-UNIT	 9300611599643

Flextool® Pumps

Flextool Pumps are highly efficient submersible units which are operated by petrol or diesel portable drive units. Flextool pumps are completely self-priming and extremely robust in their design. The flexible shaft drive facilitates use in many situations where close coupled pumps would not be suitable. The new FP212 series now come with flexshaft support springs which protect the drive shaft when operating over the sharp edge of excavations, pits, dams, etc.

FLEXTOOL 212 PUMP PERFORMANCE GRAPH

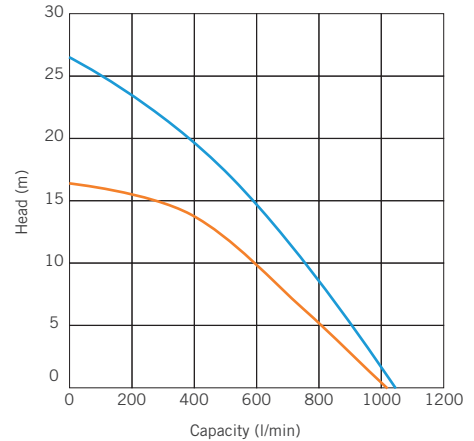

— Performance at 3,600 rpm — Performance at 3,000 rpm

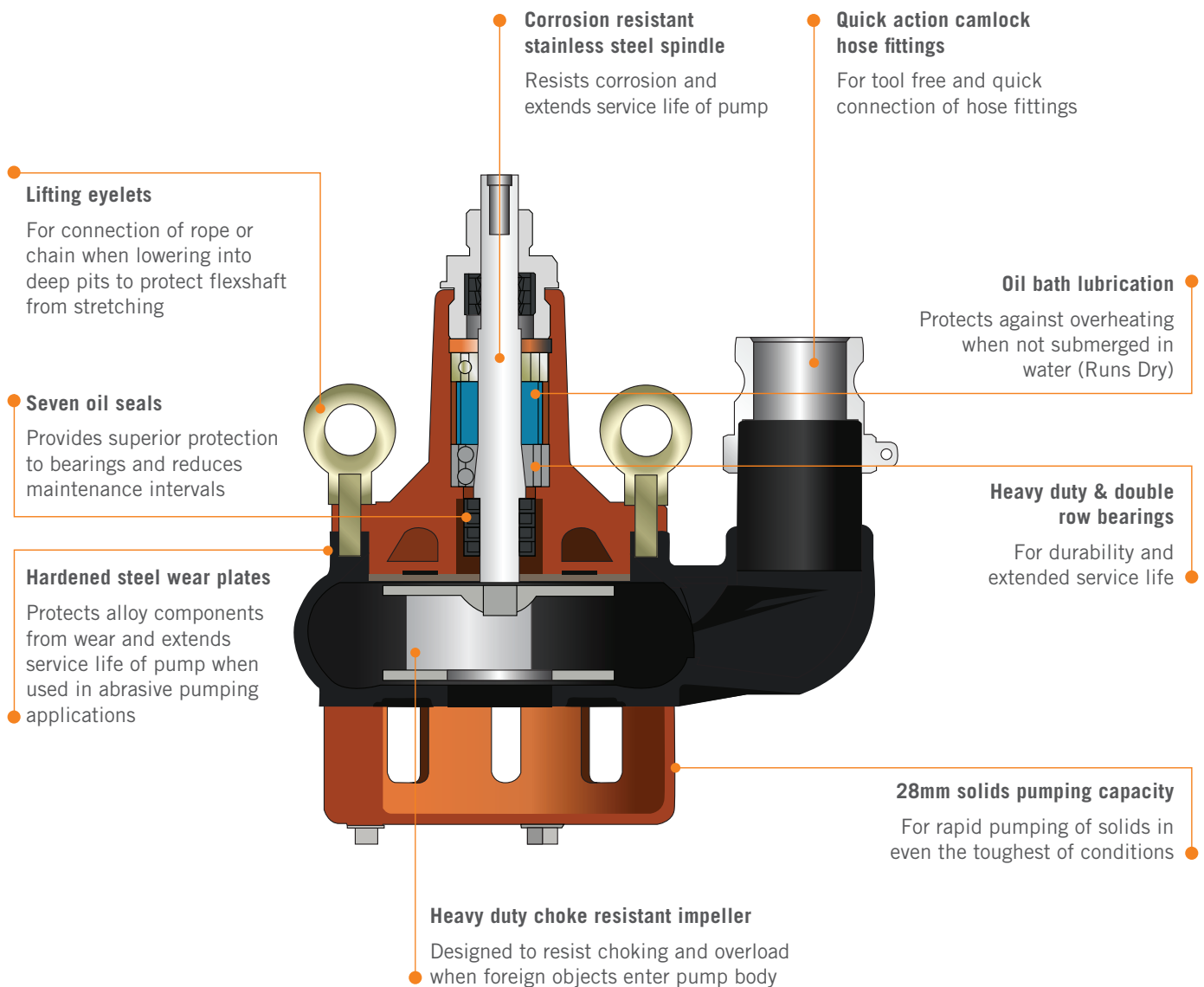

GENERAL PURPOSE PUMPS

APPLICATIONS

- Excavations pits
- Construction sites
- Pier holes
- Dams
- Swimming pools
- Trenches





Clean Water



Water with Debris



Model	Flexshaft Length (m)	Operating Weight (kg)	Shaft Inner Core Diameter (mm)	Shaft Casing Diameter (mm)	Discharge Diameter (mm)	Max Discharge Head (m)	Max Discharge (l/h)	Solids Capacity (mm)	Product Code	Barcode
FP212G-6	6	26.5	13	32	50	26	63,000	28	FT201801-UNIT	 9300611599452
FP212G-9	9	38	13	32	50	26	63,000	28	FT201803-UNIT	 9300611599483

ABRASION RESISTANT PUMPS



APPLICATIONS

- Quarries
- Sandy soils
- Sand pits
- Slurry



Slurry Water with Fine Particles



Model	Flexshaft Length (m)	Operating Weight (kg)	Shaft Inner Core Diameter (mm)	Shaft Casing Diameter (mm)	Discharge Diameter (mm)	Max Discharge Head (m)	Max Discharge (l/h)	Solids Capacity (mm)	Product Code	Barcode
FP212A-6	6	34	15	38	50	26	63,000	28	FT201805-UNIT	 9300611599506
FP212A-9	9	42.5	15	38	50	26	63,000	28	FT201818-UNIT	 9300611599636

CHEMICAL RESISTANT PUMPS*

APPLICATIONS

- Anodisers
- Industrial waste
- Salty water
- Others



Other



*Improved chemical resistance to a wide range of chemicals compared to general purpose pumps.

Model	Flexshaft Length (m)	Operating Weight (kg)	Shaft Inner Core Diameter (mm)	Shaft Casing Diameter (mm)	Discharge Diameter (mm)	Max Discharge Head (m)	Max Discharge (l/h)	Solids Capacity (mm)	Product Code	Barcode
FP212C-6	6	37.5	15	38	50	26	63,000	28	FT201817-UNIT	 9300611599629

LAY FLAT HOSE

Lay Flat Hose is a lightweight, reinforced PVC that can roll flat and save space.



Hose Type	Length (m)	Hose Diameter (mm) (in)	Fitted With	Product Code	Barcode
Blue - Std Duty	20	50 (2)	Coupling & Joiner	FT200032-UNIT	 9330221047395

FLEXTOOL EXTENSION FLEXSHAFTS

Flextool Extension Flexshafts extend the length of submersible pumps and concrete vibrators. Fitted with the same 60mm quick action coupling as the drive units, these extensions allow for quick onsite connection. Compatible with all Flextool Submersible Pumps and Flexshaft Concrete Vibrators.



APPLICATIONS

- Deep columns
- Elevated formwork
- Deep excavations

Model	Flexshaft Length	Operating Weight (kg)	Shaft Inner Core Diameter (mm)	Shaft Outer Casing Diameter (mm)	Product Code	Barcode
FES-2	6	20	13	32	FT201804-UNIT	 9300611599490

The Flextool® series of FP212 Submersible Pumps are highly efficient, robust in design and completely self-priming making them one of the most versatile pumps on the market.



Flextool® Flexshaft™ Concrete Vibrators

Australia's original series of immersion Concrete Vibrators produce high frequency vibration allowing for the efficient compaction of all types of concrete mixes. Compaction improves the strength and finish of the concrete by driving out entrapped air. The newly improved FVP series now come with three heavy duty bearings and double oil seal protection for optimum performance and longer service life.

**TRIPLE BEARING TECHNOLOGY,
SAFE AND COMFORTABLE GRIP,
AND NOW HITS TWICE AS HARD.**

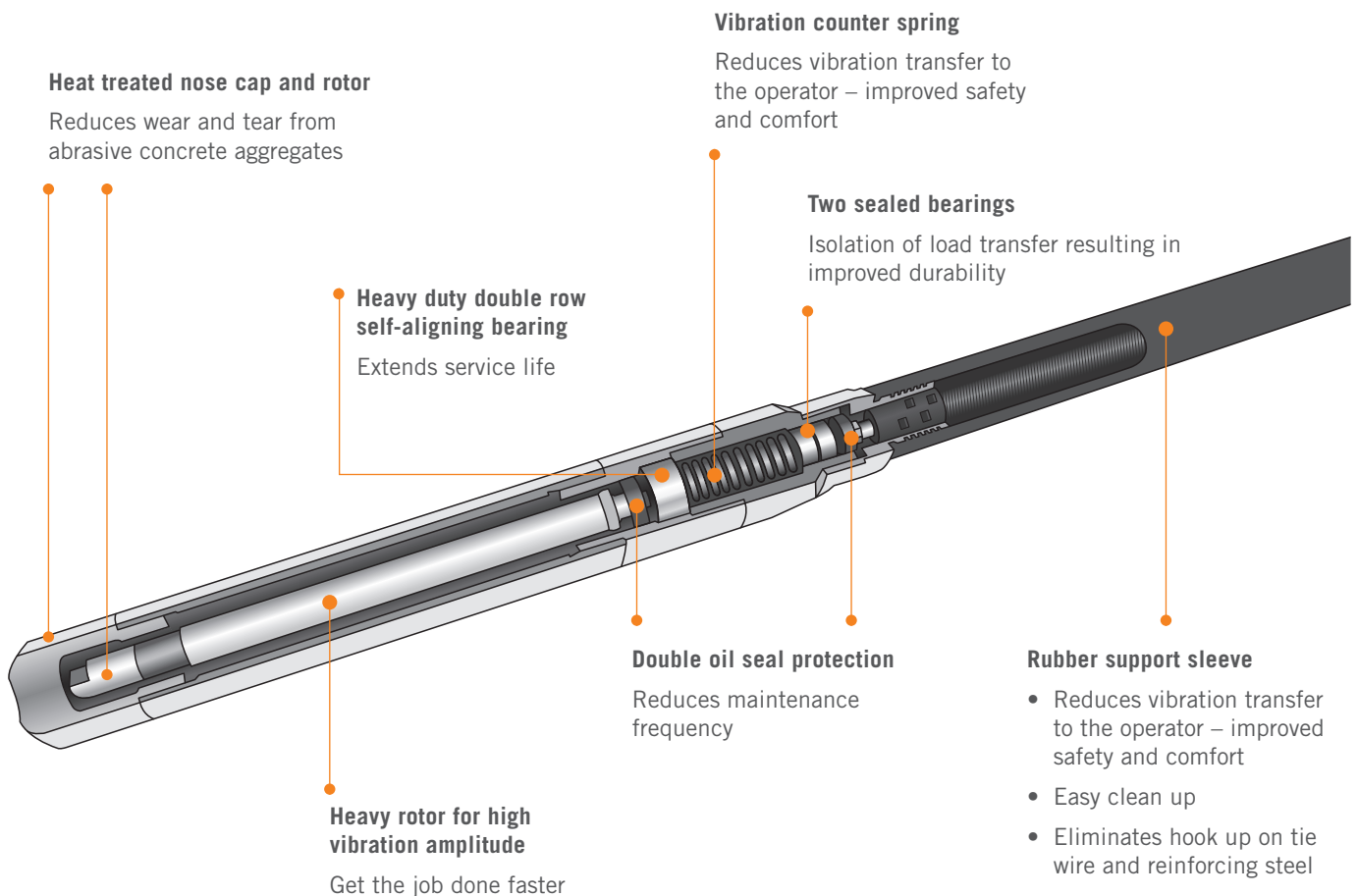

FLEXSHAFT CONCRETE VIBRATOR STEEL TIP







Model	Nose Cap Type	Vibrator Head Diameter (mm)	Flexshaft Length (m)	Operating Weight (kg)	Shaft Inner Core Diameter (mm)	Shaft Casing Diameter (mm)	Frequency (vib/min)	Frequency (Hz)	Amplitude in Air (mm)	Product Code	Barcode
FVP30-6	Steel	28	6	14	8	28	12,600	210	1.4	FT201794-UNIT	 9300611599001
FVP40-6	Steel	38	6	19	12	32	12,300	205	1.7	FT201795-UNIT	 9300611599049
FVP40-9	Steel	38	9	26	12	32	12,300	205	1.7	FT201793-UNIT	 9300611598233
FVP50-6	Steel	50	6	22	12	32	12,000	200	2.2	FT201796-UNIT	 9300611599056
FVP50-9	Steel	50	9	28	12	32	12,000	200	2.2	FT201792-UNIT	 9300611598240
FVP60-6	Steel	60	6	23	12	32	12,000	200	2.4	FT201797-UNIT	 9300611599063
FVP60-9	Steel	60	9	29	12	32	12,000	200	2.4	FT201791-UNIT	 9300611598264

FLEXSHAFT CONCRETE VIBRATOR RUBBER TIP



Immersion vibrator shafts fitted with resilient nose caps extend the life of form boards and improves off-the-form finishes.

Model	Nose Cap Type	Vibrator Head Diameter (mm)	Flexshaft Length (m)	Operating Weight (kg)	Shaft Inner Core Diameter (mm)	Shaft Casing Diameter (mm)	Frequency (vib/min)	Frequency (Hz)	Amplitude in Air (mm)	Product Code	Barcode
FVP40R-6	Rubber	38	6	19	12	32	12,300	205	1.7	FT201787-UNIT	 9300611599018
FVP50R-6	Rubber	50	6	22	12	32	12,000	200	2.2	FT201788-UNIT	 9300611599025
FVP60R-6	Rubber	60	6	23	12	32	12,000	200	2.4	FT201789-UNIT	 9300611599032
FVP60R-9	Rubber	60	9	29	12	32	12,000	200	2.4	FT201790-UNIT	 9300611598257



Flextool® Powervibe™

Featuring an integrated motor-in-barrel design, inline inverter and RCD protection to provide first-class operator safety and comfort. The high frequency vibration technology achieves optimum vibration consistency resulting in more efficient consolidation of concrete when operating under load.



Inline inverter control box

- Fully sealed and weather proof

Easy connection

- Operates from a standard 240 Volt / 10 amp power outlet

Operator safety

- Inline RCD to protect operator
- Light weight operation

Operator comfort

- Low vibration and heat transfer to operator
- No fumes during operation
- Low noise operation

High frequency technology

- Greater vibration consistency for optimum consolidation of concrete

Vibrator head

- Available in 45 mm & 60 mm diameters
- Hardened steel for extended service life



FLEXTOOL® POWERVIBE™



FPV-45



FPV-60

Model	Operating Weight (kg)	Vibrator Head Diameter (mm)	Vibrator Head Length (mm)	Flexshaft Length (m)	Amplitude (mm)	Centrifugal Force (kN)	Vibration (vpm)	Voltage (v)	Current (A)	Power Cable Length (m)	Shipping Dimensions (L x W x H) (mm)	Shipping Weight (kg)	Product Code	Barcode
FPV-45	17.7	45	368	6	2	2.6	12000	240	6	10	890 x 730 x 120	19.7	FT201831-UNIT	 9300611629159
FPV-60	20.5	60	436	6	2.2	4.5	12000	240	6	10	890 x 730 x 120	22.5	FT201832-UNIT	 9300611629166

Flextool® PortaVibe®

Flextool PortaVibe provides the ultimate solution for vibrating concrete. It is lightweight and highly portable, easy to operate and is fitted with a Honda 4-stroke engine for hassle free operation.



Honda 4-stroke engine for hassle free operation and low engine emissions.

Convenient on / off switch and throttle control built into handle.

Lightweight and balanced and is fitted with an adjustable handle and carry strap for user comfort and complete control.

Flexshaft rubber support sleeve for easier wash down and improved support when compared to metal springs.

High amplitude vibrating head for rapid consolidation of concrete.

FVE44-2

POWERED by HONDA



FLEXTOOL® PORTAVIBE®

APPLICATIONS

- Vibrating slabs
- Footings
- Stairways
- Footpaths



POWERED by
HONDA

Model	Nose Cap Type	Vibrator Head Diameter (mm)	Flexshaft Length (mm)	Operating Weight (kg)	Frequency (vib/min)	Amplitude in Air (mm)	Engine Make	Engine Model	Max Rated Power (Hp)	Fuel Type	Product Code	Barcode
FVE44-2	Steel	44	540	11.5	9,000	2.8	Honda	GX35	1.5		FT201807-UNIT	 9300611599520



Flextool® PortaVibe® Backpack

The Flextool PortaVibe Backpack concrete vibrator combines performance and comfort. The ergonomic contouring aluminium frame design and 4-point fully adjustable padded harness evenly distribute weight to both shoulders and hips to improve user comfort whilst reducing back strain and fatigue.

Heavy duty yet lightweight frame

- Fully welded aluminium for extra strength

Honda GX35 engine

- Hassle free operation
- Low engine emissions

Easy access control

- Swing control arm for easy RPM adjustment and access to emergency shut off switch

Vibration isolators and swivel base

- Isolates vibration transfer to the operator
- Swivel base for improved manoeuvrability and reduced back strain



Storage pouch

- Safely store personal items such as smart phones

Fully adjustable 4-point harness

- Even weight distribution for improved comfort
- Breathable padding
- Heavy duty nylon fabric for strength and easy cleaning

Flexshafts

- Available in 2 m & 3 m lengths
- Rubber support sleeve for reduced vibration transfer to operator

Quick connect fitting



- Quick screw fitting for easy fitting of flexshaft

Vibrator head

- Available in 34 mm & 44 mm diameters
- Hardened steel for extended service life

POWERED by **HONDA**

FLEXTOOL® PORTAVIBE® BACKPACK - BACKPACK



Model	Operating Weight (kg)	Engine Make	Engine Model	Max Rated Power (Hp)	Fuel Type	Product Code	Barcode
FVE-BP	7.7	Honda	GX35	1.5		FT201857-UNIT	 9300611623317



FVE-BP



ACCESSORIES

FLEXTOOL® PORTAVIBE® BACKPACK - FLEXSHAFTS

Model	Operating Weight (kg)	Flexshaft Length (m)	Coupling Type	Product Code	Barcode
FVE-F2	3.9	2	Screw & Spline	FT201858-UNIT	 9300611623331
FVE-F3	5.5	3	Screw & Spline	FT201859-UNIT	 9300611623348



FLEXTOOL® PORTAVIBE® BACKPACK - VIBE HEADS

Model	Operating Weight (kg)	Vibrator Head Diameter (mm)	Nose Cap Type	Frequency (vib/min)	Frequency (Hz)	Amplitude in Air (mm)	Product Code	Barcode
FVE-H34	2.3	34	Steel	9,000	160	1.5	FT201860-UNIT	 9300611623355
FVE-H44	3.2	44	Steel	9,000	150	2.8	FT201861-UNIT	 9300611623362



Flextool® PortaTrowel®

The PortaTrowel's light weight design improves operator safety and allows for earlier commencement of concrete finishing when compared to heavier walk behind machines.

Matched with multi-use combination blades and a variable-length pole, this unit achieves optimum control from up to 3 meters away and allows the operator to complete finishing works without the need to step foot on the wet concrete



- **Honda GX35 engine**
 - Hassle free operation
 - Low engine emissions

- **Control from up to 3m away**
 - Variable length pole/stick for optimised control when inishing concrete
 - *Clip Together handles sold separately

- **Easy control directional steering function**
 - Allows for precise movement of the PortaTrowel by twisting the handle from side to side

- **Light weight design**
 - Improved operator comfort and safety
 - Efficient Operation

- **Blade pitch function of up to 25 degrees**
 - Allows for the PortaTrowel to be used for initial floating of the wet concrete right through to final finishing

- **Robust, durable and fully sealed inline planetary gearbox**
 - Hassle free for extended operation

POWERED by HONDA

FLEXTOOL® PORTATROWEL®



FPT-30

Model	Trowel diameter (mm) (in)	Operating weight (kg)	Number of blades	Speed range (RPM)	Blade pitch max (deg)	Engine make / model	Max rated power (Hp)	Fuel type	Shipping dimensions (LxWxH) (mm)	Shipping weight (Kg)	Product code	Barcode
FPT30	750 30"	20	4	40-70	25	Honda GX35	1.5Hp		775 x 775 x 480	25	FT201898-UNIT	 9300611630216

ACCESSORIES

FLEXTOOL® PORTATROWEL® REPLACEMENT BLADES FOUR PACK

Rotor diameter	Suits machine model	No. blades per rotor	Size (mm)	Shipping dimensions (LxWxH) (mm)	Weight (kg)	Blades per pack	Product Code	Barcode
30"	PortaTrowel FPT30	4	150 x 265	150 x 265 x 20	1.9kg	4	FT201533-UNIT	 9300611630223



FLEXTOOL® CLIP TOGETHER HANDLE

Description	Maximum number of handles	Product Code	Barcode
Flextool Clip Together Handle 180 mm	Max 3 handles to be used at one time. Additional handles will result in reduced control of the PortaTrowel	FT401806-UNIT	 9300611599766



Note: Only Clip Together handles can be used with the PortaTrowel FPT30 (Telescopic Handle does not fit)

Flextool® Walk-Behind Power Trowels

The FT series 2 of Walk-Behind Power Trowels are available in 34" and 40" working widths. These trowels are robust, durable and safe concrete power finishing units. They are used to create a level, smooth finish on a large, flat area of concrete slabs.



POWERED by
HONDA

FLEXTOOL® WALK-BEHIND POWER TROWELS

POWERED by
HONDA



FT34-2

FT40-2

Model	Operating Weight (kg)	Trowel Diameter (mm) (in)	Number of Blades	Rotor Speed Range (rpm)	Blade Pitch Max (deg)	Lifting Hook	Wheel Kit Compatibility	Engine Make & Model	Max Rated Power (Hp)	Fuel Type	Product Code	Barcode
FT34-2	82	865 (34)	4	70-150	28	Yes	Yes	Honda GX160	5.5		FT201808-UNIT	 9300611599537
FT40-2	90	1015 (40)	4	70-150	28	Yes	No	Honda GX160	5.5		FT201816-UNIT	 9300611599612

ACCESSORIES

WHEEL KIT 34"

Suits FT34-2 only



Model	Operating Weight (kg)	Product Code	Barcode
FTWK-2	7	FT201809-UNIT	 9300611599544

WALK-BEHIND POWER TROWEL ENGINE COVER

Suits all FP and FT series of Walk-Behind Power Trowels



Product Code	Barcode
FT203433-UNIT	 9300611555977

COMBINATION BLADES

Suits Model	Size (mm)	Product Code
FT34-2	185 x 322	FT201821-UNIT
FT40-2	195 x 370	FT201822-UNIT



FINISHING BLADES

Suits Model	Size (mm)	Product Code
FT34-2	150 x 325	FT201823-UNIT
FT40-2	150 x 375	FT201824-UNIT



*See the Trowel Blades and Pan Floats selection guide on page 28.

Flextool Profinish® Walk-Behind Power Trowels

The Profinish Walk-Behind Power Trowels are built for the professional tradesmen. Fitted with cast iron spider plates, blade tilt levers and pressure plates these precision engineered components ensure the best possible flat floor results are achieved on each and every slab. Equipped with highly efficient gearboxes, maximum torque is transferred to the trowel rotors for superior performance at low, medium and high RPM.

Fatigue reducing body contoured, padded handle bar provides operator comfort.

Easy access to all three handle mounted operating controls provides greater user safety.

Central lifting hook for easy and safe onsite handling.

Heavy duty gearboxes designed for the toughest panning, floating and finishing applications.

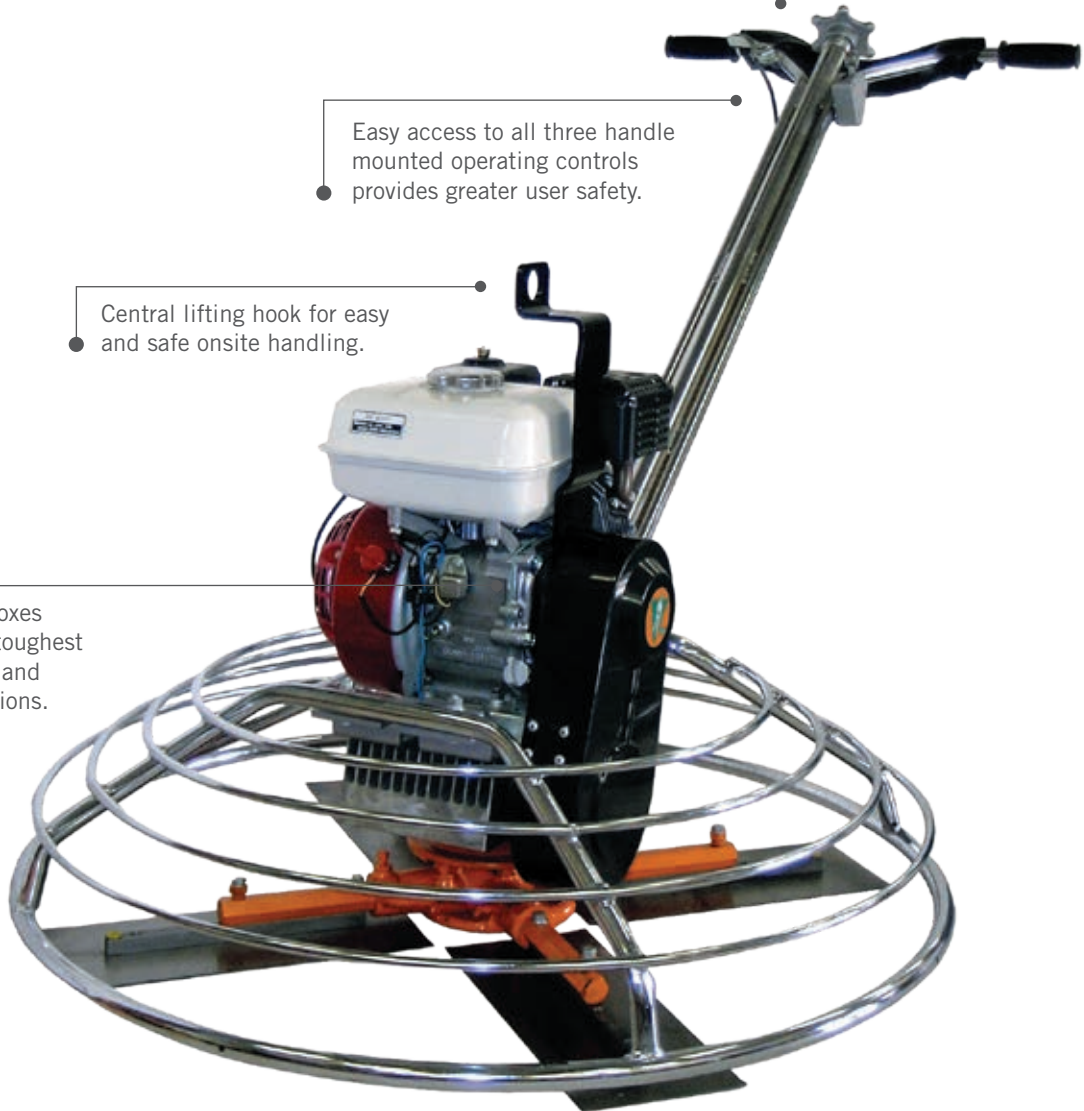

FP436

POWERED by
HONDA

FLEXTOOL PROFINISH® WALK-BEHIND POWER TROWELS



FP424

*Pan included



FP436



FP436D



FP440



FP446





POWERED by
HONDA

POWERED by
HONDA

YANMAR

POWERED by
HONDA

YANMAR

Model	Trowel Diameter (mm) (in)	Operating Weight (kg)	Number of Blades	Speed Range (rpm)	Blade Pitch Max (deg)	Engine Make	Engine Model	Max Rated Power (Hp)	Fuel Type	Product Code	Barcode
FP424	610 (24)	50	4	40-130	30	Honda	GX160	5.5	P	FT203424-UNIT	 9330221045476
FP436	915 (36)	75	4	40-130	30	Honda	GX160	5.5	P	FT203436-UNIT	 9330221045414
FP436D	915 (36)	89	4	50-130	30	Yanmar	L48	4.7	D	FT23436D-UNIT	 9330221045407
FP440	1015 (40)	85	4	40-130	30	Honda	GX270	9	P	FT203440-UNIT	 9330221045384
FP446	1165 (46)	105	4	40-150	30	Honda	GX390	13	P	FT203446-UNIT	 9330221045377

ACCESSORIES

WALK-BEHIND POWER TROWEL ENGINE COVER

Suits all FP and FT series of Walk-Behind Power Trowels

Product Code	Barcode
FT203433-UNIT	 9300611555977



COMBINATION BLADES

Suits Model	Size (mm)	Product Code
FP436, FP436D & FP440	205 x 355	FT220479-UNIT
FP446	205 x 455	FT220480-UNIT



FINISHING BLADES

Suits Model	Size (mm)	Product Code
FP424	120 x 230	FT220455-UNIT
FP436, FP436D & FP440	152 x 355	FT220414-UNIT
FP446	152 x 460	FT220410-UNIT



*See the Trowel Blades and Pan Floats selection guide on page 28.

Flextool Profinish® Ride-On Power Trowels

The FP series 3 of Ride-On Power Trowels offer exceptional power to weight ratios, they are the ultimate force in tackling concrete pours of all sizes. Powerful engines deliver maximum performance to the heavy-duty gearboxes resulting in a perfect finish every time.

FP1046-3

- Removable engine access panel for fast access to engine and critical drive line components for service and repair.
- Twin stick, multi-directional levers deliver immediate, responsive steering.
- Lifting points for balanced lifting on and off the job site.
- Heavy duty gearboxes provide longer service life and less maintenance.

Forklift pockets for easy and safe handling (FP1046-3 only).

Wheel kit for easy onsite manoeuvrability. (included with all Ride-On models).

**FLEXTOOL PROFINISH®
RIDE-ON POWER TROWELS**



FP836-3



Dimensions (LxWxH)
1950mm x 1000mm x 1250mm



FP1046-3

Dimensions (LxWxH)
2500mm x 1300mm x 1400mm



Model	Operating Weight (kg)	Trowel Diameter (mm) (in)	Number of Blades	Rotor Speed Range (rpm)	Blade Pitch Max (deg)	Fuel / Water Tank Capacity (l)	Lifting Hook	Wheel Kit Inclusion	Engine Make & Model	Max Rated Power (Hp)	Fuel Type	Product Code	Barcode
FP836-3	385	915 (36)	8	50-140	30	20	Yes	Yes	Honda GX690	27	P	FT201828-UNIT	 9300611601049
FP1046-3	520	1165 (46)	10	50-140	30	20	Yes	Yes	Vanguard 613400	35	P	FT201829-UNIT	 9300611601056

ACCESSORIES

COMBINATION BLADES

Suits Model	Size (mm)	Product Code
FP836-3	205 x 355	FT220479-UNIT
FP1046-3	205 x 455	FT220480-UNIT



FINISHING BLADES

Suits Model	Size (mm)	Product Code
FP836-3	152 x 355	FT220414-UNIT
FP1046-3	210 x 460	FT2WX185-UNIT



PAN FLOAT

Suits Model	Size (mm)	Product Code
FP836-3	940	FT211691-UNIT
FP1046-3	1175	FT2H3505-UNIT



*See the Trowel Blades and Pan Floats selection guide on page 28.

TROWEL BLADE & PAN FLOAT SELECTION GUIDE

FINISHING BLADE



Finishing blades are designed to produce a smooth and polished finish to the concrete surface. After the slab has firmed up, blade pitch is increased to a greater angle resulting in a smooth and polished finish.

Rotor Diameter	Suits Machine Model (Walk-Behind & Ride-On)	No. Blades Per Rotor	Size (mm)	Size (in)	Weight (kg)	Blades Per Pack	Product Code	Barcode
24"	Walk-Behind FP424	4	120 x 230	4.75" x 9"	2.20	4	FT220455-UNIT	 9330221037501
34"	Walk-Behind FT34 & FT34-2	4	150 x 325	6"x 12.75"	4.70	4	FT201823-UNIT	 9300611599681
36"	Walk-Behind FP436 & FP436D Ride-On FP836, FP836-2 & FP836-3	4	152 x 355	6" x 14"	4.80	4	FT220414-UNIT	 9330221037563
40"	Walk-Behind FT40 & FT40-2	4	150 x 375	6"x 14.75"	5.90	4	FT201824-UNIT	 9300611599698
40"	Walk-Behind FP440	4	152 x 355	6" x 14"	4.80	4	FT220414-UNIT	 9330221037563
46"	Walk-Behind FP446 Ride-On FP846	4	152 x 460	6" x 8"	6.20	4	FT220410-UNIT	 9330221037587
	Ride-On FP1046-2, FP1046-3 & FP1046-H	5	210 x 460	8" x 18"	12.75	5	FT2WX185-UNIT	 9330221153713

Product disclaimer:





Flextool parts are designed for Flextool equipment. Flextool parts can be compatible with other brands of equipment, however, this Trowel Blade & Float Pan Selection Guide summarises our best knowledge of the products, including the compatibility based on the information available at the time. You should read this document carefully and consider the information in the context of how the product will be used, including in conjunction with any other product and the type of surfaces to, and the manner in which, the product will be used. Our responsibility for products sold is subject to our standard terms and conditions of sales. Parchem does not accept any liability either directly or indirectly for any losses suffered in connection with the use of the product whether or not in accordance with any advice, specification, recommendation or information given by it.

TROWEL BLADE & PAN FLOAT SELECTION GUIDE

COMBINATION BLADE



Combination blades are designed for operators who wish to use one blade for both floating and finishing applications. During the initial stages of power trowelling the blade is set flat and is used for floating, as the slab firms up the blade pitch is increased to produce a smooth finish.





Rotor Diameter	Suits Machine Model (Walk-Behind & Ride-On)	No. Blades Per Rotor	Size (mm)	Size (in)	Weight (kg)	Blades Per Pack	Product Code	Barcode
30"	PortaTrowel FPT30	4	150 x 265	7.25" x 12.50"	1.9kg	4	FT201533-UNIT	 9300611630223
34"	Walk-Behind FT34 & FT34-2	4	185 x 322	7.25" x 12.50"	7.20	4	FT201821-UNIT	 9300611599667
36"	Walk-Behind FP436 & FP436D	4	205 x 355	8" x 14"	6.00	4	FT220479-UNIT	 9330221037495
40"	Ride-On FP836, FP836-2 & FP836-3							
40"	Walk-Behind FT40 & FT40-2	4	195 x 370	7.75" x 14.50"	8.30	4	FT201822-UNIT	 9300611599674
46"	Walk-Behind FP446	4	205 x 455	8" x 18"	8.00	4	FT220480-UNIT	 9330221037471
	Ride-On FP846	5						

PAN FLOAT

Pan floats clip onto both finishing or combination blades. Pan floats with their large surface area achieve flatter floors than traditional float blades as they are more efficient in removing imperfections, bumps and voids.



*intermediate pans with slight bend

24"	Walk-Behind FP424	4	605	24"	5.00	N/A	FT211766-UNIT	 9330221039178
36"	Walk-Behind FP436 & FP436D	4	940	37"	17.60	N/A	FT211691-UNIT	 9330221039291
40"	Ride-On FP836, FP836-2 & FP836-3							
40"	Walk-Behind FP440	4	1050	41.25"	23.30	N/A	FT240PAN-UNIT	 9330221036849
46"	Walk-Behind FP446	4	1230	48.5"	29.40	N/A	FT211692-UNIT	 9330221039277
46"	Ride-On FP846							
46"	Ride-On FP1046-2, FP1046-3 & FP1046-H	5	1175	46.25"	30.00	N/A	FT2H3505-UNIT	 9330221036696

Flextool® PortaScreed® FPS-3

Featuring high frequency vibration across the entire width of the extrusion blade, the PortaScreed FPS-3 delivers accurate and high-quality screeding that is much faster than traditional screeding methods. The FPS-3 has been optimised to improve operator comfort and efficiency, incorporating handle vibration isolators for reduced vibration transfer, a fully adjustable twin handle system for easy height adjustment and a sturdy spring-loaded kickstand for straightforward re-fueling and storage.



Operator comfort

- Engine protection guards
- Padded lifting handles
- Lightweight and portable

No assembly required

- Simply adjust the handles to your desired height

Side exhaust Honda GX35 engine

- Reduced Fumes

Spring loaded kickstand

- Straight forward re-fueling and storage

Handle vibration isolators

- Reduced vibration transfer to the operator

Quick change extrusion blades

- Change blades in two minutes

High frequency vibration

- Fast accurate finishes

Special blade extrusion profile

- Cuts, folds and smooths concrete

Rounded extrusion blade ends

- Easy negotiation of obstacles

POWERED by HONDA

**FLEXTOOL®
PORTASCREED® FPS-3**

FLEXTOOL® PORTASCREED® – ENGINE KIT



Model	Operating Weight (kg)	Engine Make	Engine Model	Max Rated Power (Hp)	Fuel Type	Shipping Dimensions (L x W x H) (mm)	Shipping Weight (kg)	Product Code	Barcode
FPS-3	16	Honda	GX35	1.5		600 x 440 x 690	18	FT201833-UNIT	 9300611636843

FLEXTOOL® PORTASCREED® - EXTRUSIONS

Length (mm)	Weight (kg)	Product Code	Barcode
1200	2.9	FT201811-UNIT	 9300611599568
2400	5.8	FT201812-UNIT	 9300611599575
3000	7.3	FT201813-UNIT	 9300611599582
3600	8.7	FT201814-UNIT	 9300611599599
4800	10.2	FT201815-UNIT	 9300611599605



DOUBLE BEAM SCREEDS

Flextool Double Beam Screeds are an efficient means of levelling and compacting large areas of concrete. Contractors can save labour and increase placement rates as a vibrating screed strikes and compacts concrete in one pass. The vibratory motion of the beams imparts a self-propelling motion to the screed assisting it to travel over the concrete. Pre-tensioned beams on both 6.5m and 8.2m models allow the surface flatness to be controlled by adjusting beam pretension and are recommended for precision finishing. Pull ropes & handles are provided for directional control along with two lifting eyes to facilitate safe and easy onsite handling.

FEATURES

- Pretensioned beams for precision finishing (6.5 & 8.2m only)
- Honda GX160 Engine for reliability
- Non-corrosive aluminium beams for reduced weight and easy cleaning
- Vibration depth to 200mm
- Lifting / crane points for safe and easy onsite handling
- Powerful sealed vibrator with heavy duty bearings and oil bath lubrication for maintenance free operation

APPLICATIONS

- Roadways
- Airport Aprons
- Tilt & Precast Panels
- Warehouse Floors
- Rail Construction
- Bridge Decks



DOUBLE BEAM SCREED ENGINE KIT - PART 1

Operating Weight (kg)	Engine Make	Engine Model	Max Rated Power (Hp)	Fuel Type	Product Code	Barcode
37	Honda	GX160	5.5		FT202050-UNIT	 9330221049559

DOUBLE BEAM SCREED BEAMS - PART 2

Weight (kg)	Length (m)	Pre Tensioned	Product Code	Barcode
45	4.1	No	FT201320-UNIT	 9330221035071
80	6.5	Yes	FT201532-UNIT	 9330221050968
94	8.2	Yes	FT201611-UNIT	 9330221050692

Allen® 12HED Steel Truss Screenshot

The Allen Truss Screenshot Petrol 12HED is suitable for use when high tolerance FL numbers are specified on concrete floors and pavements. For more than 40 years, Allen Truss Screens have set the industry standard for precision levelness, rigidity and durability.

FEATURES

- Lowest slump concrete - 75mm (3")
- Maximum depth concrete - 200mm (8")

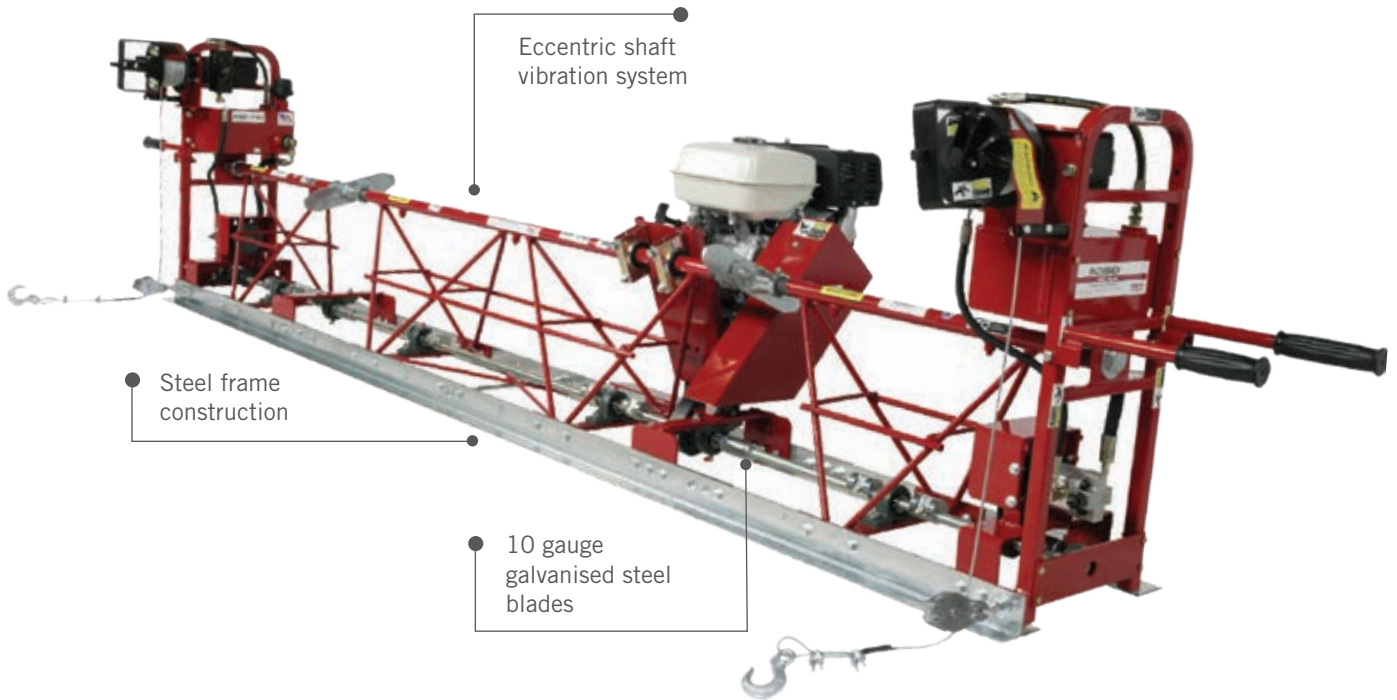

Manual Winch Kit





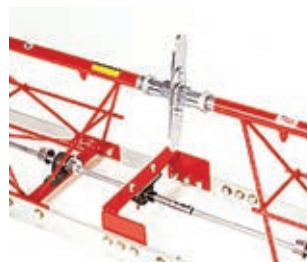



Bridge Deck End Bracket & Roller Assy





Quick Disconnect System

POWERED by
HONDA

ALLEN® 12HED STEEL TRUSS SCREED

Product Code	Description	Weight	Barcode
FT227879-UNIT	AEC Truss Screed - Engine Kit 1 Honda GX270 9HP * use with screeds 3.1m to 15.2m	52	 9300611560339
FT228327-UNIT	AEC Truss Screed - Engine Kit 2 Honda GX340 11HP * use with screeds 10.6m to 19.8m	54	 9330221152686
FT225894-UNIT	AEC Truss Screed 12HED - End Handle Set	16	 9300611560346
FT228363-UNIT	AEC Truss Screed 12HED - Hydraulic Power Winch Kit	113	 9300611568854
FT206000-UNIT	AEC Truss Screed 12HED - Bridge Deck System End Bracket	72	 9330221041706
FT222977-UNIT	AEC Truss Screed 12HED - Bridge Deck System Roller Assembly	30	 9330221042307
FT220230-UNIT	AEC Truss Screed 12HED - U-Joint Kit	10	 9300611560360

AEC TRUSS SCREED 12HED SECTIONS





Product Code	Length (m)	Weight (kg)	Barcode
FT222379-UNIT	1.5	41	 9330221152693
FT222378-UNIT	2.3	61	 9300611560353
FT228379-UNIT	3.1	82	 9330221152679

Flextool® Hand Tools



POINTED TROWELS

Pointed trowels are used for trowelling concrete floors and other general concrete work. The pointed nose of the trowel provides flexibility when trowelling around corners and protrusions in the concrete whilst also reducing marks left in the concrete. Flextool pointed trowels are produced using high carbon steel to optimise blade flexibility and durability. Flextool pointed trowels are also fitted with a single piece forged aluminium spine for extra strength and blade support. Available in both ProSoft rubber grip and solid moulded plastic handles.

Product Code	Description	Width (mm)	Length (mm)	Pack Qty	Barcode
FT4P1009-UNIT	Pointed Trowel - ProSoft Handle	100	355	6	 9330221000987
FT4P1001-UNIT	Pointed Trowel - ProSoft Handle	120	365	6	 9330221001052
FT4P1091-UNIT	Pointed Trowel - ProSoft Handle	115	405	6	 9330221000833
FT4P1092-UNIT	Pointed Trowel - ProSoft Handle	115	450	6	 9330221000819
FT4P1093-UNIT	Pointed Trowel - ProSoft Handle	115	500	6	 9330221000802
FT41009P-UNIT	Pointed Trowel - Plastic Handle	100	355	6	 9330221156912
FT41091P-UNIT	Pointed Trowel - Plastic Handle	115	405	6	 9330221156929



ProSoft Handle



Hard Plastic Handle

SQUARE TROWELS

Square trowels are used where pointed trowels are not suitable and for general concrete work. Suitable for use on concrete stairs and other vertical applications. Flextool square trowels are produced using high carbon steel to optimise blade flexibility and durability. Flextool square trowels are also fitted with a single piece forged aluminium spine for extra strength and blade support. Available with ProSoft rubber grip handles in both closed and open style configurations.

Product Code	Description	Width (mm)	Length (mm)	Pack Qty	Barcode
FT4P1002-UNIT	Square Trowel - ProSoft Handle	120	280	6	 9330221001038
FT4P1081-UNIT	Square Trowel - ProSoft Handle	115	405	6	 9330221000857
FT410020-UNIT	Square Trowel - ProSoft Open Handle	120	280	6	 9330221154246
FT410810-UNIT	Square Trowel - ProSoft Open Handle	115	405	6	 9330221154253



STEEL FLOATS



Steel Floats or “Sides Up” trowels as they are sometimes referred to are used for creating a non-slip finish on the concrete surface, also known as a stippled or coved finish. They are also used for trowelling dry shake materials into the top surface of the concrete. Steel floats produce a finer texture to wood floats and are more durable and longer wearing due to their solid steel blade. Available with ProSoft rubber handle for user comfort.

Product Code	Description	Width (mm)	Length (mm)	Pack Qty	Barcode
FT42009S-UNIT	Stainless Steel Float - ProSoft Handle	160	210	6	 9330221000734
FT42029S-UNIT	Stainless Steel Float - ProSoft Handle	100	290	6	 9330221000697
FT42019S-UNIT	Stainless Steel Float - ProSoft Handle	150	380	6	 9330221000710



MAGNESIUM FLOATS

Magnesium Floats are used in the early stages of concrete placement for working the concrete and bringing moisture to the surface. They can also be used again in the late stages of concrete finishing to create a fine textured finish similar to a steel or wood float. All Flextool magnesium floats are produced with a broken-in or curved blade and come standard with a ProSoft rubber grip for user comfort.

Product Code	Description	Width (mm)	Length (mm)	Pack Qty	Barcode
FT4P2051-UNIT	Magnesium Float - ProSoft Handle	80	405	6	 9330221000659
FT4P2052-UNIT	Magnesium Float - ProSoft Handle	80	510	6	 9330221000635



WOOD FLOATS



Wood Floats are used for creating a rough non-slip or textured finish on the concrete surface. Used predominately for outdoor areas such as footpaths and other pedestrian traffic applications. Available with ProSoft rubber handle for user comfort.

Product Code	Description	Width (mm)	Length (mm)	Pack Qty	Barcode
FT4P8001-UNIT	Wood Float - ProSoft Handle	112	300	6	 9330221000437
FT4P8002-UNIT	Wood Float - ProSoft Handle	112	380	6	 9330221000420
FT4P8024-UNIT	Wood Float - ProSoft Handle	65	600	6	 9330221000406



MARBLE SHEEN TROWELS

Marble Sheen trowels offer maximum blade flexibility due to their short blade support spine, developed initially for finishing swimming pools these tools can be used in a wide range of applications where a curved finish is required. Constructed using super flexible high carbon steel and available with ProSoft rubber handle for user comfort.

Product Code	Description	Width (mm)	Length (mm)	Spine Length (mm)	Pack Qty	Barcode
FT4P1021-UNIT	Marble Sheen Trowel - ProSoft Handle	100	350	160	6	 9330221000956
FT4P1022-UNIT	Marble Sheen Trowel - ProSoft Handle	100	450	160	6	 9330221000949



CONCRETE EDGERS - BEVEL

Concrete Edger trowels are used to create a smooth finish to slab edges. Available with ProSoft handle for user comfort.

Product Code	Description	Width (mm)	Length (mm)	Angle	Bevel (mm)	Pack Qty	Barcode
FT44013S-UNIT	Edger - ProSoft Handle	100	150	45	25	6	 9330221000529



CONCRETE EDGERS - BULL NOSE

Concrete Edger Bull Nose trowels are used to create a smooth finish to slab edges. They produce a curved profile finish on the concrete edge to prevent chipping and damage to the concrete. Available with ProSoft handle for user comfort.

Product Code	Description	Width (mm)	Length (mm)	Radius (mm)	Depth (mm)	Pack Qty	Barcode
FT44001S-UNIT	Edger - ProSoft Handle	75	140	5	12	6	 9330221000574
FT44002S-UNIT	Edger - ProSoft Handle	75	140	6	12	6	 9330221000567
FT44003S-UNIT	Edger - ProSoft Handle	75	140	10	19	6	 9330221000550
FT44008S-UNIT	Edger - ProSoft Handle	75	140	19	19	6	 9330221000536
FT44006S-UNIT	Edger - ProSoft Handle	100	150	6	14	6	 9330221000543
FT47006S-UNIT	Edger - ProSoft Handle	105	150	10	14	6	 9330221000468
FT47002S-UNIT	Edger - ProSoft Handle	112	175	12	22	6	 9330221000482
FT47003S-UNIT	Edger - ProSoft Handle	112	175	25	19	6	 9330221000475
FT47008S-UNIT	Edger - ProSoft Handle	140	200	20	19	6	 9330221000451
FT47001S-UNIT	Edger - ProSoft Handle	150	230	25	24	6	 9330221000499



VEE JOINTERS - STEEL

Vee Jointer steel trowels are used to control shrinking and cracking of concrete by inducing cracks to occur at the desired position and in a straight line. Available in ProSoft handle for user comfort.

Product Code	Description	Width (mm)	Length (mm)	Depth (mm)	Pack Qty	Barcode
FT43001S-UNIT	Vee Jointer - ProSoft Handle	75	152	10	6	 9330221000628
FT43002S-UNIT	Vee Jointer - ProSoft Handle	150	175	12	6	 9330221000611
FT43012S-UNIT	Vee Jointer - ProSoft Handle	150	175	20	6	 9330221000581



VEE JOINTERS - CAST

Vee Jointer heavy duty cast iron trowels are used to control shrinking and cracking of the concrete by inducing cracks to occur at the desired position and in a straight line. Available in ProSoft handle for user comfort.

Product Code	Description	Width (mm)	Length (mm)	Depth (mm)	Pack Qty	Barcode
FT4FP11A-UNIT	Vee Jointer - ProSoft Handle	75	150	10	6	 9330221000796
FT4FP13B-UNIT	Vee Jointer - ProSoft Handle	75	150	12	6	 9330221000789
FT4FP18E-UNIT	Vee Jointer - ProSoft Handle	75	200	25	6	 9330221000772



STEP TREAD TOOL - CAST

The Step Tread Tool is designed to create non-slip safety step grooves on concrete stairs and walkways. It creates seven grooves over a 75mm trowel width. Available in ProSoft handle for user comfort.

Product Code	Description	Width (mm)	Length (mm)	No. Grooves	Pack Qty	Barcode
FT4FP19G-UNIT	Step Tread Tool - ProSoft Handle	75	150	7	6	 9330221000765



CONCRETE SCREED WITH LEVEL VIAL



Flextool Concrete Screeds are made from durable yet lightweight aluminium extrusions. Concrete screeds are used to level the concrete after it has been placed. Flextool screeds are designed with dual cutting edges and clamped handles allowing the screed to be reversed for use on the other side. These screeds are fitted with a level vial to assist with accurate and level screeding, and they are also fitted with plastic end caps and are powder coated for easy cleaning.



Product Code	Description	Length (mm)	Pack Qty	Barcode
FT401807-UNIT	Aluminium Concrete Screed	1200	4	 9300611599773
FT401808-UNIT	Aluminium Concrete Screed	1500	4	 9300611599797
FT401809-UNIT	Aluminium Concrete Screed	1800	4	 9300611599803
FT401810-UNIT	Aluminium Concrete Screed	2100	4	 9300611599810
FT401811-UNIT	Aluminium Concrete Screed	2400	4	 9300611599827
FT401812-UNIT	Aluminium Concrete Screed	2700	4	 9300611599834
FT401813-UNIT	Aluminium Concrete Screed	3000	4	 9300611599841
FT401814-UNIT	Aluminium Concrete Screed	3600	4	 9300611599858
FT401815-UNIT	Aluminium Concrete Screed	4200	4	 9300611599865

CONCRETE PLACING RAKES



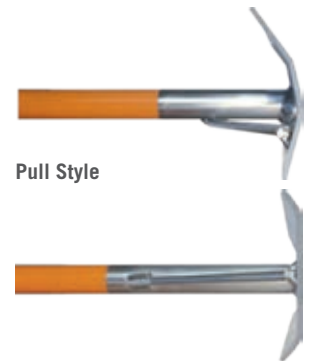

Product Code	Description	Blade Width (mm)	Length (mm)	Pack Qty	Barcode
FT4CC011-UNIT	Concrete Placing Rake - Pull Style	500	1650	6	 9330221155304
FT4CC013-UNIT	Concrete Placing Rake - Push / Pull Style	500	1650	6	 9330221155328



Push/Pull Style

CONCRETE SHOVELS

Product Code	Description	Length (mm)	Pack Qty	Barcode
FT4HGT75-UNIT	Steel D - Handle Concrete Shovel	1050	6	 9319646112390
FT4RW025-UNIT	Steel D - Handle Concrete Shovel	1150	6	 9330221155335



STANDING BRACKET

Product Code	Description	Pack Qty	Barcode
FT40FPSB-UNIT	Standing Bracket	1	 9300611572912



KNEELING BOARD

Kneeling boards are for multipurpose use by concreters & flooring contractors and provide comfortable and soft support. They are constructed using dense polyurethane foam and heavy duty polypropylene tray for improved strength.

Product Code	Description	Width (mm)	Length (mm)	Pack Qty	Barcode
FT410209-UNIT	Concrete Kneeling Board	350	490	6	 9330221083126



HANDLES & ADAPTORS



Telescopic Extension Handle



Telescopic Handle Adaptor



Clip Together Handle



Replacement Handle

Product Code	Description	Pack Qty	Barcode
FT401805-UNIT	Handle Telescopic Extension	4	 9300611599759
FT401800-UNIT	Handle Telescopic Adaptor 25-32mm	50	 9300611599704
FT401806-UNIT	Handle Clip Together 1.8m	4	 9300611599766
FT42051H-UNIT	Replacement Handle - Mag & Wood Float	6	 9330221083119

SUITABLE FOR USE WITH CLIP TOGETHER OR TELESCOPIC HANDLES

BULLFLOATS

For use with Telescopic or Clip Together Handles

Product Code	Description	Width (mm)	Length (mm)	Pack Qty	Barcode
FT401801-UNIT	Aluminium Bullfloat	150	600	4	 9300611599711
FT401802-UNIT	Aluminium Bullfloat	150	900	4	 9300611599728
FT401803-UNIT	Aluminium Bullfloat	150	1200	6	 9300611599735
FT401804-UNIT	Aluminium Bullfloat	150	1800	4	 9300611599742



FINISHING BROOMS





For use with Telescopic or Clip Together Handles

Product Code	Description	Length (mm)	Bristle Type	Pack Qty	Barcode
FT4B1573-UNIT	Finishing Broom	750	Medium	10	 9330221001175
FT4B1574-UNIT	Finishing Broom	900	Medium	10	 9330221001168



WALKING TOOLS

For use with Telescopic or Clip Together Handles

Product Code	Description	Width (mm)	Length (mm)	Radius (mm)	Depth (mm)	Pack Qty	Barcode
FT4009SW-UNIT	Walking Tool - Steel Float	160	210	-	-	6	 9330221000727
FT4019SW-UNIT	Walking Tool - Steel Float	150	380	-	-	6	 9330221000703
FT4002SW-UNIT	Walking Tool - Edger	112	175	12	22	6	 9330221154369
FT4702SW-UNIT	Walking Tool - Vee Joints	150	175	-	12	6	 9330221154376



WALKING TROWELS

For use with Telescopic or Clip Together Handles

Product Code	Description	Width (mm)	Length (mm)	Pack Qty	Barcode
FT4FW555-UNIT	Walking Trowel - Round Ends - Carbon Steel	120	600	6	 9330221001526
FT4FW557-UNIT	Walking Trowel - Round Ends - S/Steel	120	600	6	 9330221001519





FRESNO TROWELS

For use with Telescopic or Clip Together Handles

Product Code	Description	Width (mm)	Length (mm)	Pack Qty	Barcode
FT4FF607-UNIT	Fresno Trowel	115	600	6	 9330221001090
FT4FF609-UNIT	Fresno Trowel	115	900	6	 9330221001083



BOLT CUTTERS

Product Code	Description	Length (mm)	Pack Qty	Barcode
FT4RW094-UNIT	Bolt Cutters	750	5	 9330221001229
FT4RW095-UNIT	Bolt Cutters	900	5	 9330221001212



FLAT FLOOR TOOLS

These extruded magnesium flat floor tools are specifically designed to improve floor or pavement flatness. Each tool comes standard with three 1.8m clip-together aluminium handles, stabilising outriggers and equalizer pitch adjusting head for precise, even control.

BUMP CUTTER Cuts down bumps and fills low areas after concrete slab has been floated.

CHECK ROD Reduces bumps and fills low areas while the concrete is still plastic.

CHANNEL FLOAT Use in place of traditional bull floats for flatter floors.

Product Code	Description	Width (mm)	Height (mm)	Length (mm)	Pack Qty	Barcode
FT4000BC-UNIT	Bump Cutter	3000	102	51	1	 9330221002677
FT4000CR-UNIT	Check Rod	3000	51	102	1	 9330221002653
FT4000CF-UNIT	Channel Float	3000	51	152	1	 9330221002660

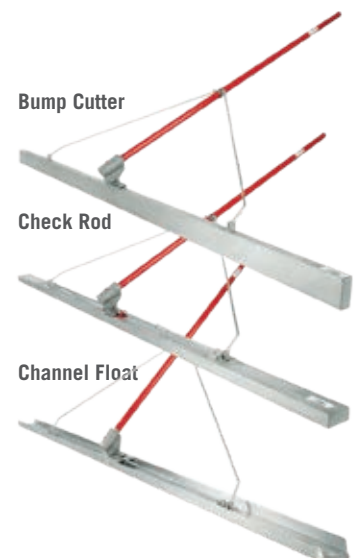

HEAVY DUTY BULLFLOAT

These heavy duty bullfloats are the concrete placers workhorse. This hard wearing tool is made from the highest quality extruded material for added strength and longer life. Comes complete with H/D worm pitch drive and three 1800mm clip together handles.

Product Code	Description	Length (mm)	Pack Qty	Barcode
FT450084-UNIT	Heavy Duty Bullfloat	1200	1	 9330221002639



ACCESSORIES

Product Code	Description	Pack Qty	Barcode
FT240680-UNIT	Heavy Duty Pitch Control Mechanism	1	 9330221087575



MATERIAL SPREADER

Used for spreading dry shake materials such as Sicaltop & Decorative colour hardeners.

FEATURES

- 40kg hopper capacity
- Adjustable spreading rate from 0.5kg/m² to 2.5kg/m²
- Mesh roller pushes material to the surface
- Hopper includes integrated bag breakers
- Hand activated lever opens/closes discharge gate to start/stop material flow

Product Code	Description	Pack Qty	Barcode
FT4TV830-UNIT	Material Spreader	1	 9330221086066





Flextool® PortaPac®

Suitable for all trades, the PortaPac FCP-48 is designed for ultimate manoeuvrability. Incorporating a narrow base plate, the PortaPac can complete soil compaction works in tight and restricted spaces where larger plate compactors cannot fit. In addition, the built-in wheel kit eliminates the need to manually lift the PortaPac while around the job site. Portability is optimised with a central lifting point for safe and easy lifting, plus folding handles for straightforward transportation.



FCP-48

POWERED by HONDA

Model	Operating Weight (kg)	Plate Size (WxL) (mm)	Centrifugal Force Max (kN)	Vibration Frequency (vpm)	Max Travel Speed (m/min)	Max Gradeability (%)	Max Compacted Area (m ² /h)	Lifting Hook	Engine Make & Model	Max Rated Power (Hp)	Fuel Type	Product Code	Barcode
FCP-48	48	310 x 430	8.5	5140	22	32	410	Yes	Honda GX100	3		FT201870-UNIT	 9300611634993



Flextool® Forward Plate Compactor

The Flextool FCP-87B Forward Plate Compactor is suitable for a wide range of compaction applications. This unit is highly portable, easily manoeuvrable and delivers excellent compaction results.



FCP-87B

POWERED by
HONDA

Model	Operating Weight (kg)	Plate Size (WxL) (mm)	Centrifugal Force Max (kN)	Vibration Frequency (vpm)	Max Travel Speed (m/min)	Max Gradeability (%)	Max Compacted Area (m ² /h)	Lifting Hook	Engine Make & Model	Max Rated Power (Hp)	Fuel Type	Product Code	Barcode
FCP-87B	87	460 x 610	19.8	7000	26	35	717	Yes	Honda GX160	5.5	 FT201806-UNIT	FT201806-UNIT	 9300611599513



SOIL COMPACTION



Mikasa soil compactors have been exported to the Australian market and worldwide since 1968.



Tamping Rammers

For use in confined spaces such as trenches and deep excavations for compacting soil & backfill.



Reversible Plate Compactors

Used for compacting larger areas and also trenches with its forward and reverse directional capabilities.



Forward Plate Compactors

Used for compacting thin layers such as road base and asphalt.



Mikasa® Forward Plate Compactors

Mikasa Forward Plate Compactors are suitable for the compaction of sub bases and asphalt. They offer superior build quality and excellent performance. These compactors are highly portable, easily manoeuvrable and deliver excellent compaction results.

Engine Protection Frame and Lifting Hook

Integrated engine protection frame with lifting hook protects the engine from impact during operation and transport.

Water Tank

Ideal for the asphalt work and suppression of dust.

MVC-T90H



Sealed Clutch and Belt Guard

Protects against the ingress of dust and other unwanted materials that can prematurely wear out critical clutch components and V-Belt.

Self Lubricating Vibrator System – (Patented)

Uses the rotation of the eccentric exciter weights to ensure even dispersion of oil to the bearings for improved service life.

Special Compaction Base Plate

Mikasa compactors use a highly durable ductile iron baseplate for longer life.

POWERED by **HONDA**

MIKASA® FORWARD PLATE COMPACTORS



MVCF60H

POWERED by
HONDA



MVCF80H

POWERED by
HONDA







MVC-T90H

POWERED by
HONDA





MVC-T100D

YANMAR

Model	Operating Weight (kg)	Plate Size (w x d) (mm)	Centrifugal Force (Max) (kN)	Vibration Frequency (VPM)	Max Travel Speed (m/min)	Max Gradeability (%)	Max Compacted Area (m²/h)	Lifting Hook	Wheel Kit	Water Tanks	Engine Make & Model & Max Rated Power (Hp)	Fuel Type	Product Code	Barcode
MVC F60H	68	350 x 510	10.1	5,600	25	35	525	Yes	Yes	Option	Honda GX120 4.0	P	FT272785 -UNIT	 9300611636805
MVC F80H	81	450 x 570	13.7	5,600	25	35	675	Yes	Yes	Option	Honda GX160 5.5	P	FT272786 -UNIT	 9300611636812
MVC-T90H	91	500 x 525	15	6,000	25	35	750	Yes	Option	Yes	Honda GX160 5.5	P	FT2CT90H -UNIT	 9300611572790
MVC-T100D	103	500 x 525	15	6,000	25	35	750	Yes	Option	Yes	Yanmar L48 4.7	D	FT2T100D -UNIT	 9300611572806

ACCESSORIES

WHEEL KIT

Model	Serial No.	Product Code	Barcode
MVC-T90H	Y1066 - A1616 AND C3807 - CURRENT	FT231599-UNIT	 9300611572820
	A2583 - C3257	FT231594-UNIT	 9300611577313
MVC-T100D		FT231599-UNIT	 9300611572820

WATER TANKS

Model	Product Code
MVCF60H	NPS05148-UNIT
MVCF80H	NPS05149-UNIT

Mikasa® Tamping Rammers

Mikasa 4-stroke Tamping Rammers are perfectly balanced to deliver hard hitting compaction while ensuring operator comfort through reduce noise and low Vibration Absorbing System handle.

Central Lifting Hook

Easy and safe onsite handling.

Engine Hour Meter

Hour meter for management of service intervals and it also monitors engine RPM for optimum compaction performance.



Cyclonic Air Filtration System

For superior air filtration to lengthen service internals and improve engine protection.



Fully Integrated Control Switch

Controls On / Off switch, Fuel Tap and Engine Throttle all in one lever.



Handle Roller

Easy loading into vehicles and the unit can also lie down to 90° for transport.

Low Vibration Handles

Vibration Absorbing System for reduced hand and arm vibration transfer to the operator.

Hand- arm vibration (HAV) is vibration transmitted to a person's hand and arm when using hand-held power tools, hand guided machinery like small compaction equipment or while holding materials being processes by plant.

- Exposure to HAV can lead to
- Hand- arm vibration syndrome
 - Carpal tunnel syndrome (CTS)

Engine Guard

Fully protected engine to eliminate damage to critical engine components.



Honda 4 Stroke Engine

Low emissions, easy starting and quiet operation.

POWERED by **HONDA**



MTX-60E



MIKASA® TAMPING RAMMERS



MTR-40H
Shoe Size (WxL)
100mm x 270mm

POWERED by
HONDA



MTX-60E
Shoe Size (WxL)
265mm x 340mm

POWERED by
HONDA



MTX-70E
Shoe Size (WxL)
285mm x 340mm

POWERED by
HONDA



MTX-85DYC
Shoe Size (WxL)
285mm x 340mm

YANMAR

Model	Operating Weight (kg)	Jumping Stroke (mm)	Impact Rate (blows/m)	Impact Force (Max) (kN)	Average Travel Speed* (m/min)	Compaction Depth* (cm)	Engine Make & Model	Max Rated Power (Hp)	Average HAV (m/s ²)	Fuel Type	Fuel Tank Capacity (L)	Product Code	Barcode
MTR-40H	46	40-55	644-695	5.4	10-12	20-30	Honda GX100	3	17.9	P	2	FT201691-UNIT	 9300611599360
MTX-60E	64	50-80	644-695	13.6	10-12	50-85	Honda GX100	3	5.2	P	2.5	FT2TX60E-UNIT	 9300611572813
MTX-70E	75	50-80	644-695	14.9	10-12	45-70	Honda GX100	3	5.6	P	3	FT2MTX70-UNIT	 9330221073660
MTX-85DYC	93	50-80	656-698	15.7	10-12	50-85	Yanmar L48N	4.7	18.5	D	3.3	FT285DYC-UNIT	 9300611619570

ACCESSORIES

REPLACEMENT SHOE

Model	Product Code	Barcode
MTR-40H & MTR-40F	NPS71383-UNIT	 9330221071383
MT-55 & MTX-60E	NPS70638-UNIT	 9330221070638
MT-65HA, MTX-70E, MT-76D & MTX-85DYC	NPS70430-UNIT	 9330221070430

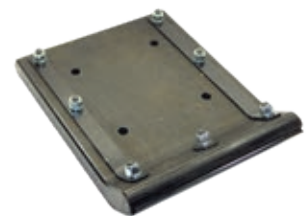

TRENCHING SHOE (115MM WIDE X 330MM HIGH)

MT-55 & MTX-60E	NPS51907-UNIT	 9330221068772
MT-65HA, MTX-70E, MT-76D & MTX-85DYC	NPS51919-UNIT	 9330221068765



TRENCHING SHOE (165MM WIDE X 330MM HIGH)

MT-65HA, MTX-70E, MT-76D & MTX-85DYC	NPS51931-UNIT	 9330221068758
--------------------------------------	---------------	-------------------

WHEEL KIT

Product Code	Operating Weight (kg)	Suits	Wheel Diametre (mm)	Wheel Type	Barcode
FT201692-UNIT	11	MTX Series Rammers	260	Solid Flat Free Urethane	 9300611624123



Mikasa® Reversible Plate Compactors

Mikasa Reversible Plate Compactors are ideal for the efficient compaction of sand, gravel and cohesive soils in trenches and large construction projects. They offer high compaction capacity, superior travel speeds and feature fully hydraulic direction control for easy direction change. They are ideally suited for civil construction works, drainage contractors and the rental industry.



Cyclonic Air Filtration System

For superior air filtration to lengthen service internals and improve engine protection.



Forward/Reverse Control Lever (Patented)

The control lever has been engineered with a built-in actuator that provides seamless and smooth transition between both forward and reverse travel motion.



Anti Vibration & Adjustable Handle

Reduces operator fatigue by significantly reducing handle vibration. Handle is also height adjustable for improved operator comfort.

Engine Protection Frame & Lifting Hook

Robust frame provides superior protection against engine damage, also fitted with a built in lifting hook for safe on site handling.

Tough & Rugged Body

Full engine protection frame that provides superior protection to the engine, air filtration system and battery against unwanted damage. Special hinge design allows easy access to the engine for ease of maintenance and servicing.



Engine Hour Meter

Hour meter for management of service intervals.



Removable Extension Plates

Easily adjust the width of the plate to match your job requirements.

Enclosed Belt Guard

Provides superior protection of drive belt and clutch against dust & debris.

MVH-308

MIKASA® REVERSIBLE PLATE COMPACTORS



MVH-R60

Plate Size (WxL)

Without extension plates:
350mm x 480mm

With extension plates:
N/A



MVH-158

Plate Size (WxL)

Without extension plates:
430mm x 700mm

With extension plates:
N/A



MVH-158DY

Plate Size (WxL)

Without extension plates:
430mm x 700mm

With extension plates:
N/A



MVH-308

Plate Size (WxL)

Without extension plates:
445mm x 860mm

With extension plates:
595mm x 860mm



MVH-308

Plate Size (WxL)

Without extension plates:
445mm x 860mm

With extension plates:
595mm x 860mm



MVH-508







Plate Size (WxL)

Without extension plates:
650mm x 900mm

With extension plates:
800mm x 900mm



*Extension plate supplied as standard.

Model	Operating Weight		Centrifugal Force (Max) (kN)	Vibration Frequency (VPM)	Max Travel Speed (m/min)	Max Gradeability (%)	Max Compacted Area (m ² /h)	Engine Make / Model	Max Rated Power (Hp)	Average HAV (m/s ²)	Fuel Type	Product Code	Barcode
	Without extension plates (kg)	With extension plates (kg)											
MVH-R60	68	N/A	15	6,000	25	35	525	Honda GX120	4	N/A	P	FT2VHR60-UNIT	 9330221073486
MVH-158	145	N/A	27	5,400	26	35	670	Honda GX200	6.5	N/A	P	FT201690-UNIT	 9300611599353
MVH-158DY	164	N/A	25	5400	26	35	670	Yanmar L48N	3.5	N/A	D	FT272784-UNIT	 9300611634160
MVH-308	310	325	45	4,400	27	35	963	Honda GX270	9	2.8	P	FT272776-UNIT	 9300611572776
MVH-308	341	361	45	4,400	27	35	963	Yanmar L70N	6.7	2.9	D	FT272783-UNIT	 9300611572783
MVH-508	525	567	65	4,150	29	35	1392	Hatz 1D81S	14.1	5.5	D	FT28DSZN-UNIT	 9300611572769

Flextool® Brick & Masonry Saw

Flextool Brick & Masonry Saw offers high precision cutting of bricks and building blocks. It is easy to set up and transport.

Button for water control on top handle for easy control of water flow.



Powder coated and anodised brick saw.

Trolley complete with foot pedal, pneumatic wheels and handles.

FBS-36E

*Blades not included

Model	Blades Size (mm) (in)	Max Depth Cut (mm)	Max Length of Cut (mm)	Operating Weight (kg)	Lifting Hook	Voltage (V)	Max Current (amp)	Power Output (kw)	Power Output (Hp)	Product Code	Barcode
FBS-36E	355 (14)	125	500	110	Yes	240	10	1.7	2.3	FT109503-UNIT	 9330221030618

BRICK BLADE (LASER WELDED GOLD)

Brick Blade (Laser Welded Gold) commonly used on table saws and brick saws for cutting hard materials such as clay bricks and pavers. Can also be used on petrol powered hand saws and floor saws under 24HP for cutting very hard concrete. Recommended for wet use only.

Product Code	Description	Blade Diameter (mm) (in)	Arbour Size (mm)	Segment Height (mm)	Barcode
FT1W350T-UNIT	Bladetec Diamond Blade (Gold)	355 (14")	25.4	12	 9330221028387



BRICK BLADE (SILENT)

Premium quality Brick Blade (Silent) Blade with a sandwich type steel core designed to keep cutting noise down to a minimum. Used for cutting hard clay bricks and pavers and non abrasive blocks. Should be operated only on brick and bench saws under 5HP and used with water.

Product Code	Description	Blade Diameter (mm) (in)	Arbour Size (mm)	Segment Height (mm)	Barcode
FT150SLP-UNIT	Bladetec Diamond Blade (Brick/Silent)	355 (14")	25.4	12	 9330221027755



CONCRETE BLADE (LASER WELDED WHITE)

Concrete Blade (Laser Welded White) for general purpose cutting of both reinforced and non-reinforced concrete. Can be used on hand held petrol saws and floor saws under 24HP. Should be used wet.

Product Code	Description	Blade Diameter (mm) (in)	Arbour Size (mm)	Segment Height (mm)	Barcode
FT11350T-UNIT	Bladetec Diamond Blade (White)	355 (14")	25.4	12	 9330221028196
FT11400T-UNIT	Bladetec Diamond Blade (White)	415 (16")	25.4	12	 9330221028165
FT11450P-UNIT	Bladetec Diamond Blade (White)	460 (18")	25.4	12	 9330221028141
FT11500P-UNIT	Bladetec Diamond Blade (White)	510 (20")	25.4	12	 9330221028134



COMBINATION BLADE (CONCRETE / ASPHALT)



Combination Blade (Concrete / Asphalt) used for cutting a mixture of concrete and softer materials such as asphalt, sandstone and besser brick. Can be used on hand held petrol saws, floor saws under 24HP and bench/brick saws. Should be used wet.

Product Code	Description	Blade Diameter (mm) (in)	Arbour Size (mm)	Segment Height (mm)	Barcode
FT1C300T-UNIT	Bladetek Diamond Blade (Combi)	305 (12")	25.4	12	 9330221028110
FT1C350T-UNIT	Bladetek Diamond Blade (Combi)	355 (14")	25.4	12	 9330221028097
FT1C400T-UNIT	Bladetek Diamond Blade (Combi)	415 (16")	25.4	12	 9330221028073
FT1C450P-UNIT	Bladetek Diamond Blade (Combi)	460 (18")	25.4	12	 9330221028066
FT1C500P-UNIT	Bladetek Diamond Blade (Combi)	510 (20")	25.4	12	 9330221028059



ASPHALT BLADE (LASER WELDED BLACK)

Asphalt Blade (Laser Welded Black) for all asphalt cutting applications with a drop segmented for under-cut protection. Used on floor saws under 25HP. Should be used wet.

Product Code	Description	Blade Diameter (mm) (in)	Arbour Size (mm)	Segment Height (mm)	Barcode
FT12350T-UNIT	Bladetek Diamond Blade (Black)	355 (14")	25.4	12	 9330221028028
FT12400T-UNIT	Bladetek Diamond Blade (Black)	415 (16")	25.4	12	 9330221028004
FT12450P-UNIT	Bladetek Diamond Blade (Black)	460 (18")	25.4	12	 9330221027601



ALL CUT BLADE (VACUUM BRAZED TECHNOLOGY)

New technology Vacuum Brazed Blade for general type cutting of most materials including concrete, masonry, metal, wood, plastic, steel, cast iron, copper, brick, cement sheet, timber, tree roots, PVC, rubber and polycarbonate. Mainly used on petrol powered hand saws and can be used both wet and dry. Also known as a rescue blade.

Product Code	Description	Blade Diameter (mm) (in)	Arbour Size (mm)	Segment Height (mm)	Barcode
FT11GVT7-UNIT	Bladetec Diamond Blade (All-Cut)	355 (14")	25.4	12	 9330221028233



WIDE SEGMENT BLADE (PROFESSIONAL)

A Professional 10mm Wide Segment Blade used for cutting and clean out of construction joints in concrete flooring. Should be used on floor saws under 25HP only.

Product Code	Description	Blade Diameter (mm) (in)	Arbour Size (mm)	Segment Height (mm)	Barcode
FT15010W-UNIT	Bladetec Diamond Blade 10mm Wide (CONC)	355 (14")	25.4	12	 9330221027977





ACCESSORIES

Product Code	Description	Barcode
FT200031-UNIT	Bladetec Diamond Blade Spacer 25.4mm to 20mm Reduces arbour size to suit both hand held and walk behind floor and road saws	 9330221016421

CONTINUOUS RIM

Continuous Rim Blade for use on power tools and tile saws for precise and chip free cutting of granite, ceramic, terracotta and porcelain tiles. Can be used both wet or dry.

Product Code	Description	Blade Diameter (mm) (in)	Segment Height (mm)	Barcode
FT1B105T-UNIT	Bladetec Diamond Blade (Cont Rim)	105 (4")	8	 9330221021357
FT1B125T-UNIT	Bladetec Diamond Blade (Cont Rim)	125 (5")	8	 9330221021319



TURBO RIM (ABRASIVE)





Premium quality Turbo Rim (Abrasive) Blade for cutting softer type materials giving fast efficient cutting with extended life. Types of materials recommended for cutting include concrete blocks/pavers, sandstone and aerated concrete. Can be used both wet or dry.

Product Code	Description	Blade Diameter (mm) (in)	Segment Height (mm)	Barcode
FT103580-UNIT	Bladetec Diamond Blade Green Saw	230 (9")	10	 9330221015448



TURBO RIM



Turbo Rim Blade used in a variety a general purpose cutting applications where a chip free cut is not required. Used for cutting materials such as clay and concrete bricks, cement sheet, general concrete (not reinforced), concrete roof tiles and clay/concrete pipes. Can be used both wet or dry.

Product Code	Description	Blade Diameter (mm) (in)	Segment Height (mm)	Barcode
FT1F105T-UNIT	Bladetec Diamond Blade (Turbo)	105 (4")	10	 9330221022491
FT1F125T-UNIT	Bladetec Diamond Blade (Turbo)	125 (5")	10	 9330221022439
FT1F180T-UNIT	Bladetec Diamond Blade (Turbo)	180 (7")	10	 9330221022385
FT1F230T-UNIT	Bladetec Diamond Blade (Turbo)	230 (9")	10	 9330221022347



9.5mm WIDE TUCK POINT



Premium quality 9.5mm Wide Tuck Point Blade used for tuck pointing and cleaning of mortar joints. Most commonly used by the professional in dry application.

Product Code	Description	Blade Diameter (mm) (in)	Segment Thickness (mm)	Segment Height (mm)	Barcode
FT1105P9-UNIT	Bladetec Diamond Blade (Tuck Point)	100 (4")	9.5	12	 9330221028998
FT1125P9-UNIT	Bladetec Diamond Blade (Tuck Point)	125 (5")	9.5	12	 9330221028936
FT1180P9-UNIT	Bladetec Diamond Blade (Tuck Point)	180 (7")	9.5	12	 9330221028905



V-SEGMENT CRACK CHASER

Premium quality V-Segment Crack Chaser Blade with a “V” type segment designed to follow and widen cracks in concrete prior to repair. Most commonly used by the professional in dry application.

Product Code	Description	Blade Diameter (mm) (in)	Segment Thickness (mm)	Segment Height (mm)	Barcode
FT1K105P-UNIT	Bladetec Diamond Blade V-Segment	100 (4")	9.5	12	 9330221029049
FT1K125P-UNIT	Bladetec Diamond Blade V-Segment	125 (5")	9.5	12	 9330221029032
FT1K180P-UNIT	Bladetec Diamond Blade V-Segment	180 (7")	9.5	12	 9330221029025











CORE DRILL

With a wide range of sizes available with 1 1/4" UNC back end fittings, Bladetec diamond core bits give the professional tradesman excellent performance in both drilling speed and life of the drill bit. Designed for drilling all types of reinforced concrete and masonry and should only be used in wet applications.



Product Code	Description	Barcode
FT1B0018-UNIT	Bladetec Core Drill 18mm	 9330221022187
FT1B0022-UNIT	Bladetec Core Drill 22mm	 9330221022163
FT1B0028-UNIT	Bladetec Core Drill 28mm	 9330221022149
FT1B0032-UNIT	Bladetec Core Drill 32mm	 9330221022132
FT1B0038-UNIT	Bladetec Core Drill 38mm	 9330221022118
FT1B0042-UNIT	Bladetec Core Drill 42mm	 9330221022101
FT1B0050-UNIT	Bladetec Core Drill 50mm	 9330221022088
FT1B0064-UNIT	Bladetec Core Drill 64mm	 9330221022064

Product Code	Description	Barcode
FT1B0076-UNIT	Bladetec Core Drill 76mm	 9330221022057
FT1B0083-UNIT	Bladetec Core Drill 83mm	 9330221022040
FT1B0092-UNIT	Bladetec Core Drill 92mm	 9330221022026
FT1B0102-UNIT	Bladetec Core Drill 102mm]	 9330221022019
FT1B0127-UNIT	Bladetec Core Drill 127mm	 9330221021982
FT1B0152-UNIT	Bladetec Core Drill 152mm	 9330221021975
FT1B0166-UNIT	Bladetec Core Drill 166mm	 9330221021968
FT1B0254-UNIT	Bladetec Core Drill 254mm	 9330221021920

Flextool® Cub Grinder

The Cub Grinder is compact in design and delivers exceptional grinding capability across a wide range of applications. With the weight of the motor sitting directly over the grinding head grinding efficiency is enhanced. Fitted with a direct drive coupling design there is no drive belts that require ongoing adjustments and timely maintenance.



FLEXTOOL® CUB GRINDER

Model	Grinding Width (mm)	Operating Weight (kg)	Lifting Hook	Voltage (volt)	Max Current (amp)	Power Output (kw)	Power Output (Hp)	Motor Speed (rpm)	IP Rating	Overload Protection	Product Code	Barcode
ART-CUB	250mm	46	Yes	240V	9.57A	1.8	2.4	1440	55	Yes	FT1RTCUB-UNIT	 9330221020817

FLEXTOOL® CUB GRINDER ACCESSORIES

Flextool's extensive range of Quick Fit Shoe and Grinding Plates are compatible with the Flextool Cub Grinder. See the selection table below to find the suitable parts.

Product Code	Description	Barcode
FT1TE250-UNIT	Bladetec Grinding Shoes Quick Fit Adaptor Plate (takes 6 x shoe)	 9330221017909



ACCESSORIES

QUICK-FIT GRINDING SHOE

Flextool Quick-Fit grinding shoes are available in a number of bond hardness for use on materials ranging from soft and porous surfaces such as rain damaged concrete and asphalt, super hard cured concrete and for the removal of epoxies and glues. Grit sizes from 16 through to 150 are available to achieve course surface finishes for overlay with thick epoxies, cement based floor coatings or for a non-slip finish through to fine finishes for semi-polished concrete or for thin floor coatings. Quick-Fit shoes provide super quick tool free knock-in and knock-out changeover of grinding shoes.

HARD CONCRETE

CONCRETE HARDNESS

SOFT CONCRETE / ASPHALT



SOFT BOND (WHITE)

Soft Bond Diamonds for floors that have been power trowelled or burned. For use on hard concrete.



MEDIUM BOND (GREY)

Medium Bond Diamonds for average strength concrete floors.







HARD BOND (BLACK)

Hard Bond Diamonds for soft floors and asphalt.

Product Code	Application	Colour	Diamond Grit Size	Number of segments per shoe	Barcode
FT124730-UNIT	Hard, Cured Concrete Floors	White	16GR	2	 9330221024730
FT1EHC20-UNIT	Hard, Cured Concrete Floors	White	20GR	2	 9330221024723
FT124716-UNIT	Hard, Cured Concrete Floors	White	30/40GR	2	 9330221024716
FT124709-UNIT	Hard, Cured Concrete Floors	White	80GR	2	 9330221024709
FT124679-UNIT	Medium Hardness Concrete	Grey	16GR	2	 9330221024679
FT1EMC20-UNIT	Medium Hardness Concrete	Grey	20GR	2	 9330221024662

QUICK-FIT GRINDING SHOE (CONTINUED)

Product Code	Application	Colour	Diamond Grit Size	Number of segments per shoe	Barcode
FT124648-UNIT	Medium Hardness Concrete	Grey	30/40GR	2	 9330221024648
FT124624-UNIT	Medium Hardness Concrete	Grey	80GR	2	 9330221024624
FT1MC150-UNIT	Medium Hardness Concrete	Grey	150GR	2	 9330221024686
FT1ABE20-UNIT	Soft, Porous Concrete Asphalt	Black	20GR	2	 9330221024761
FT1ABE40-UNIT	Soft, Porous Concrete Asphalt	Black	30/40GR	2	 9330221024754
FT1UBPCD-UNIT	Epoxies & Glue Removal	PCD (Poly Crystalline Diamond)	PCD (Poly Crystalline Diamond)	2	 9330221024792

GRINDING PLATES

Flextools Grinding Plates are available in a number of bond hardness for use on materials ranging from soft and porous surfaces such as rain damaged concrete and asphalt through to super hard cured concrete. All grinding plates are a combination 30 / 40 grit plate for general grinding applications. Grinding plates with 5 segment allow rapid grinding speeds with shorter tool life through to 20 segments for longer tool life and slower grinding speeds.



HARD CONCRETE

CONCRETE HARDNESS

SOFT CONCRETE / ASPHALT

SOFT BOND (WHITE)

Soft Bond Diamonds for floors that have been power trowelled or burned. For use on hard concrete.

MEDIUM BOND (GREY)

Medium Bond Diamonds for average strength concrete floors.

HARD BOND (BLACK)

Hard Bond Diamonds for soft floors and asphalt.

Product Code	Application	Diamond Grit Size	Number of Segments	Diamond Plate Diameter (mm) (in)	Barcode
FT105THC-UNIT	Hard, Cured Concrete Floors	30/40GR	5	250 (10")	 9330221018111
FT110THC-UNIT	Hard, Cured Concrete Floors	30/40GR	10	250 (10")	 9330221018074
FT120THC-UNIT	Hard, Cured Concrete Floors	30/40GR	20	250 (10")	 9330221018043
FT105TMC-UNIT	Medium Hardness Concrete	30/40GR	5	250 (10")	 9330221018104
FT110TMC-UNIT	Medium Hardness Concrete	30/40GR	10	250 (10")	 9330221018067
FT15TABE-UNIT	Soft, Porous Concrete Asphalt	30/40GR	5	250 (10")	 9330221018135
FT110TAB-UNIT	Soft, Porous Concrete Asphalt	30/40GR	10	250 (10")	 9330221018081

UNIVERSAL SHOE TO SUIT BMG-435 & ALL DIAMAG ADAPTER PLATES

Screw type 2-segment diamond shoes to suit the Blastrac® BMG-435 Planetary Grinder available in three bonds to cover all types of concrete grinding applications. Whether it be very hard concrete or the other end of the scale with soft abrasive concrete, shoes are available from 16 grit through to 300 grit. Poly Crystalline Diamond (PCD) shoes also available for removal of glues and epoxies which are excessively built up on concrete surfaces. Softer type “chewy” materials are no match for these PCD shoes. Available bond types: Soft, Medium, Hard. Can be used wet or dry.

1 SEGMENT GRINDING SHOES

Product Code	Application	Diamond Grit Size	Number of Segments per shoe	Barcode
FT1C201S-UNIT	Hard, Cured Concrete Floors	20GR	1	 9300611546623
FT146616-UNIT	Hard, Cured Concrete Floors	40GR	1	 9300611546616



2 SEGMENT GRINDING SHOES

Product Code	Application	Diamond Grit Size	Number of Segments per shoe	Barcode
FT119378-UNIT	Hard, Cured Concrete Floors	16GR	2	 9330221019378
FT119361-UNIT	Hard, Cured Concrete Floors	20GR	2	 9330221019361
FT119354-UNIT	Hard, Cured Concrete Floors	30/40GR	2	 9330221019354
FT119347-UNIT	Hard, Cured Concrete Floors	80GR	2	 9330221019347
FT119385-UNIT	Hard, Cured Concrete Floors	100GR	2	 9330221019385



Product Code	Application	Diamond Grit Size	Number of Segments per shoe	Barcode
FT119316-UNIT	Medium Hardness Concrete	16GR	2	 9330221019316
FT119309-UNIT	Medium Hardness Concrete	20GR	2	 9330221019309
FT119286-UNIT	Medium Hardness Concrete	30/40GR	2	 9330221019286
FT119279-UNIT	Medium Hardness Concrete	80GR	2	 9330221019279
FT119408-UNIT	Soft, Porous Concrete Asphalt	20GR	2	 9330221019408
FT119422-UNIT	Soft, Porous Concrete Asphalt	30/40GR	2	 9330221019422
FT10EPCD-UNIT	Epoxies & Glue Removal	PCD (Poly Crystalline Diamond)	PCD (Poly Crystalline Diamond)	 9330221019668



WEDGE BLOCK WHITE

Diamond Wedges with four segments are available with two different bond types. White wedges are a medium bond suitable for general grinding of medium to hard concrete. Can be used wet or dry commonly on the Flextool terrazzo grinder.

Product Code	Description	Specification	Barcode
FT10DWHC-UNIT	Bladetec Grinding Diamond Wedge White	4x12x12x40	 9330221017749



WEDGE BLOCK BLACK

Black Block Wedges are the hardest of the bonds suitable for freshly laid or abrasive concrete. Can be used wet or dry commonly on the Flextool terrazzo grinder.

Product Code	Description	Specification	Barcode
FT10DWHB-UNIT	Bladetec Grinding Diamond Wedge Black	4x12x12x40	 9330221017732



TURBO

Turbo Diamond Cup Wheel with grit diamond designed for removal of a wide range of construction materials with exceptional life. Materials include concrete, bricks, concrete pavers, stone, concrete blocks etc. Should be used dry on electric power tools.

Product Code	Description	Grit Size	Cup Wheel Diameter (mm) (in)	Arbour Size (mm)	Barcode
FT129605-UNIT	Bladetec Grinding Cup Wheel Turbo	Course	100 (4")	22.2/16	 9330221029605
FT129599-UNIT	Bladetec Grinding Cup Wheel Turbo	Fine	100 (4")	22.2/16	 9330221029599
FT129568-UNIT	Bladetec Grinding Cup Wheel Turbo	Course	125 (5")	22.2	 9330221029568
FT129551-UNIT	Bladetec Grinding Cup Wheel Turbo	Fine	125 (5")	22.2	 9330221029551
FT1GCA2C-UNIT	Bladetec Grinding Cup Wheel Turbo	Course	180 (7")	22.2	 9330221029520
FT1GCA2F-UNIT	Bladetec Grinding Cup Wheel Turbo	Fine	180 (7")	22.2	 9330221029513



SPIRAL SEG



Spiral Diamond Cup Wheels available with 9, 12 and 24 segments for aggressive grinding to more controlled type application where extended life is desired. Should be used dry on power tools or wet/dry if used on a walk behind floor grinder. Suitable for grinding concrete, bricks, concrete pavers, stone, concrete blocks etc.

Product Code	Description	Cup Wheel Diameter (mm) (in)	No. of Segments	Arbour Size (mm)	Barcode
FT1P1009-UNIT	Bladetec Grinding Cup Wheel Spiral	100 (4")	12	22.2/16	 9330221031707
FT1P1259-UNIT	Bladetec Grinding Cup Wheel Spiral	125 (5")	12	22.2	 9330221031691
FT118012-UNIT	Bladetec Grinding Cup Wheel Spiral	180 (7")	12	22.2	 9330221031684
FT118024-UNIT	Bladetec Grinding Cup Wheel Spiral	180 (7")	24	22.2	 9330221031677



PCD

Poly Crystalline Diamond Cup Wheels specifically designed for removal of glues and epoxies which are excessively built up on concrete surfaces. Softer type "chewy" materials are no match for this aggressive cup wheel. Should be used dry on power tools or wet/dry if used on a walk behind floor grinder.

Product Code	Description	Cup Wheel Diameter (mm) (in)	No. of Segments	Arbour Size (mm)	Barcode
FT125PCD-UNIT	Bladetec Grinding Cup Wheel PCD	125 (5")	12	22.2	 9330221017817
FT1PCD24-UNIT	Bladetec Grinding Cup Wheel PCD	175 (7")	24	22.2	 9330221017787



Flextool® Surface Scarifier FSP-200

Flextool Surface Scarifier is designed for use on all concrete and asphalt surfaces. With a 200mm scarifying path and rigid base design this machine is engineered with durability in mind.





POWERED by
HONDA



FLEXTOOL® SURFACE SCARIFIER FSP-200

POWERED by **HONDA**

Model	Working Width (mm)	Operating Weight (kg)	Engine Make & Model	Max Rated Power (Hp)	Fuel Type	Product Code	Barcode
FSP-200	200	87.5	Honda GX160	5.5		FT101802-UNIT	 9300611599414

CUTTER CAGE

Product Code	Description	Barcode
FT101800-UNIT	Flextool Surface Scarifier Cage (Suits FSP200)	 9300611599407



Flextool® Pressure Cleaner FBX-3000

Flextool High Pressure Water Cleaner is built for ultimate performance and durability. With 3000 pounds per square inch (PSI) this unit ensures to clean and prepare the surface with ease.



Hose reel kit option is also available to be mounted on the machine for safe and tidy stowage of high pressure hoses.

Premium engineered Annovi® Reverberi pump for durability and minimal maintenance.

Heavy duty and rugged fully welded steel frame for durability.

Honda 4-Stroke engine for trouble free operation and reduced engine emission.

Oversized 14" all terrain wheels the FBX-3000 will tackle any worksite with ease.

FBX-3000

POWERED by
HONDA

FLEXTOOL® PRESSURE CLEANER FBX-3000

APPLICATIONS

- Concrete Surface & Preparation Cleaning
- Rental Companies
- Equipment Cleaning

POWERED by
HONDA



Model	Weight (kg)	Pump Pressure (psi)	Flow (lpm)	Pump Type	Pump Speed (rpm)	Hose Length (m)	Nozzle Type	Engine Make / Model	Max Rated Power (Hp)	Fuel Type	Product Code	Barcode
FBX-3000	52	3000	11.3	Annovi Reverberi	3400	15	Snap-On	Honda GX200	6.5		FT2X3000-UNIT	 9300611560506

ACCESSORIES

Product Code	Description	Barcode
NPS80001-UNIT	Flextool High Pressure Hose Reel Kit	 9300611565594
NPS80002-UNIT	Flextool Turbo Nozzle	 9300611565600



SPS Sprayer Concrete Stainless Steel – S103E

The Smith Industrial Sprayers are built to withstand harsh chemicals and are targeted towards contractor or construction work with ease of use and durability at their core. Each sprayer is fitted with chemical-resistant seals and brass components specially designed for contact with acetone, xylene, bond breakers, curing compounds and other concrete chemicals.



NP700096-UNIT

Product Code	Description	Barcode
NP700096-UNIT	SPS Sprayer Concrete Stainless Steel – S103E	 0841688003903

From site prep to surface finishing,
Flextool® has the right equipment for the job.



Site Preparation



Concrete Placing



Concrete Finishing



Concrete Cutting



Surface Preparation





THE HOME OF LEADING BRANDS



© Copyright 2021 Parchem Construction Supplies Pty Limited. Flextool, the Flextool logo, PortaVibe, Flextool Profinish, PortaTrowel, PortaPac and PortaScreed are registered trade marks, PowerVibe is a trade mark of Parchem Construction Supplies Pty Ltd.

Mikasa and the Mikasa logo are the trade marks of Mikasa Sangyo Co. Ltd, used under licence. Honda and the POWERED BY HONDA logo are trade marks of Honda Motor Co., Ltd.

BladeTec is a registered trade mark of Concrete Plus Limited. Blastrac is the trade mark of Blastrac N.A Inc a Delaware Corporation. Allen and Allen logo are trade marks of Allen Engineering Corporation. AR Annovi Reverberi is registered trade mark of Annovi Reverberi S.P.A. Yanmar and the Yanmar logo are trade marks of Yanmar Co., Ltd. Vanguard is trade mark of Briggs & Stratton Corporation. Hatz Diesel is trade mark of Motorenfabrik Hatz GmbH & Co. KG. Smith Performance Sprayers is a trade mark. Multiquip and Whiteman are registered trade marks of Multiquip Inc. Diamatic is a trade mark of Blastrac Global.

This publication is copyright. All rights are reserved. Reproduction in whole or in part is prohibited without written permission. Application details are provided as a suggestion only of intended use. This catalogue is produced as a guide to the product range. Some items may not be available at all outlets. Owing to a continual product improvement, designs & specifications may be subject to change without notice.

Parchem Construction Supplies Pty Ltd
1956 Dandenong Rd, Clayton VIC 3168
1300 353 986
www.flextool.com.au
ABN 80 069 961 968